

FY
FUNNY
FY



FY
FUNNY
FY

Indice | Index | Index

Un innovativo sistema d'arredo che crea uno spazio di lavoro collaborativo che valorizza l'efficienza dei dipendenti. La protagonista, dal design sofisticato e moderno, è indubbiamente la scrivania, disponibile in sei strutture diverse e completamente personalizzabile combinando i numerosi materiali e i pregiati melaminici della gamma. L'ufficio raggiunge un equilibrio impeccabile risultando piacevole e accogliente, sia per chi opera in postazione singola, che in team, alla reception o al call center.

An innovative furniture system that creates a cooperative work space that enhances employee efficiency. The star player is undoubtedly the desk with its sophisticated and modern design, available with six different structures and fully customisable with the range's numerous combinations of materials and refined melamine surfaces. The office setting achieves an immaculate balance and is both appealing and welcoming for those working at an individual workstation, or in team, in reception or in a call centre.

Un système d'ameublement novateur qui crée un espace de travail collaboratif et qui stimule l'efficacité des salariés. L'acteur principal, au design sophistiqué et moderne, est indubitablement le bureau qui se décline en six structures différentes et entièrement personnalisables, alliant les nombreux matériaux et les mélaminés de qualité supérieure de la gamme. Le bureau atteint un équilibre parfait et devient agréable et accueillant, tant pour le travailleur seul à son poste que pour l'équipe de la réception ou du call center.

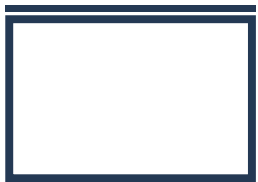

Gamba Anello pag. 4
Ring Leg
Piètement en forme d'anneau



Gamba Csquare pag. 96
Csquare Leg
Piètement à Csquare



Gamba U pag. 32
U Leg
Piètement à U



Gamba Tsquare pag. 114
Tsquare Leg
Piètement à Tsquare



Fianco Legno pag. 66
Wood Side
Côté Bois



Gamba T pag. 128
T Leg
Piètement à T



Smart Office pag. 140
Smart Office
Smart Office



Reception pag. 154
Reception
Réception

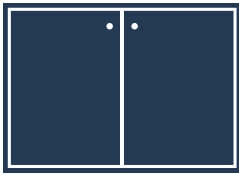

Archiviazione pag. 174
Storage
Rangement

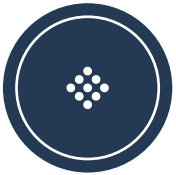

Elettrificazione pag. 184
Cable Management
Câblage

Gamba anello

Ring Leg

Piètement en forme d'anneau

Moderna e anticonvenzionale.

La struttura con Gamba anello nasce per creare soluzioni d'arredo dalla forte personalità. Si raggiunge la massima libertà di composizione con i numerosi accostamenti disponibili tra i piani in melaminico o in vetro e le finiture della struttura in metallo.

Modern and unconventional.

The structure with Ring leg was conceived to create design solutions with a powerful personality. The utmost in compositional freedom is achieved with numerous combinations available between the melamine or glass tops and the various metal structure finishes.

Moderne et non conventionnel. La structure à piètement en forme d'anneau permet de créer des solutions d'ameublement à forte personnalité. La liberté de composition maximale est obtenue grâce aux nombreuses associations disponibles entre les plans en mélaminé ou en verre et les finitions de la structure en métal.

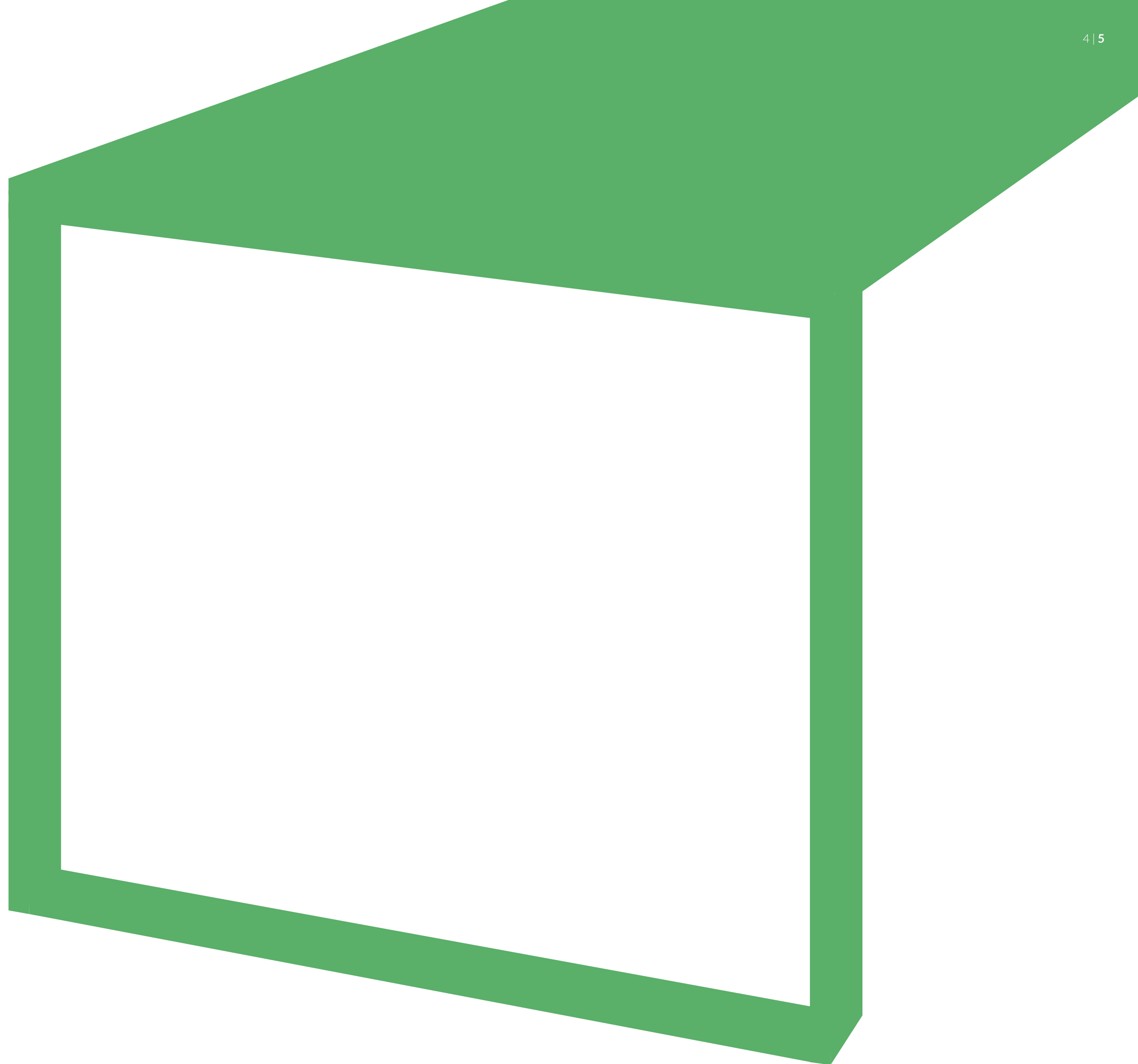



Contrasto originale tra la struttura geometrica della gamba in metallo e il piano in melaminico. Una postazione di alta classe.

Original contrast between the geometrical structure of the metal leg and the melamine top. A high-class workstation.



Contraste original entre la structure géométrique du piètement en métal et le plan en mélaminé. Un bureau haut de gamme.

Il minimalismo del metallo trasmette tutta la professionalità sia per ambienti individuali, che per le zone comuni.

The minimalist overtones of the metal convey unbounded professionalism in both individual settings and shared areas.

Le minimalisme du métal transmet tout le professionnalisme tant pour les postes individuels que pour les espaces communs.





Nessun limite compositivo.
La gamba anello si trasforma e diventa condivisa dando vita a un disegno dalla forte caratterizzazione e praticità.

No limit to compositions.
The ring leg changes form and becomes a shared element giving rise to a design which is highly practical and has a powerful character.

Aucune limite de composition.
Le piètement en forme d'anneau se transforme et se partage, créant un design très singulier et pratique.





Infinite soluzioni per l'archiviazione e il contenimento. La linea d'ufficio operativa si completa di cassettiere in metallo e mobili in melaminico con sofisticate finiture.

Infinite solutions for storage and filing. The operative office line is completed with metal drawer pedestals and storage elements in melamine with sophisticated finishes.

Des solutions d'archivage et de rangement infinies. La ligne opérationnelle de bureau est complétée par des caissons en métal et des meubles en mélaminé des finitions raffinées.







Le accoglienti postazioni di lavoro possono essere arricchite da schermi fonoassorbenti e dalla linearità eclettica della gamba anello condivisa.

The welcoming workstations can be enhanced with sound absorbing screens and the eclectic lines of the shared ring leg.

Les postes de travail accueillants peuvent être enrichis par des écrans acoustiques et par la linéarité éclectique du piètement en forme d'anneau partagé.





Il sistema d'appoggio che funge sia da archivio, che da divisorio è la soluzione perfetta per dotare la postazione di privacy e massima funzionalità.

The supporting element which acts as a storage unit and a partition is the perfect solution to provide the workstation with privacy and the utmost in functionality.

Le système d'appui, servant d'archivage ou de séparation, est la solution parfaite pour offrir au poste sa confidentialité et une fonctionnalité maximale.







La struttura perimetrale della scrivania può essere affiancata da mobili di servizio di supporto su piedini, o su ruote per facilitarne la movimentazione.

The perimeter structure of the desk can be accompanied by freestanding service units on legs, or on castors in order to facilitate movement.

La structure périmétrale du bureau peut être soutenue par des meubles de service avec soutien sur pieds ou sur roulettes qui en facilitent le déplacement.





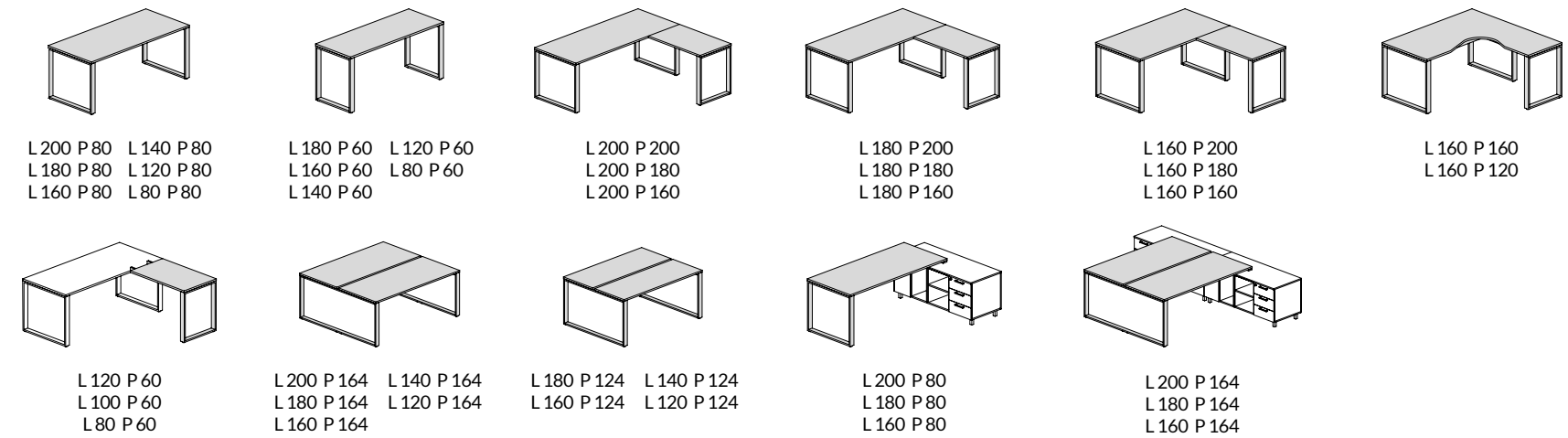

Tavoli riunione in melaminico | MFC Meeting Tables | Tables de Réunion en mélaminé

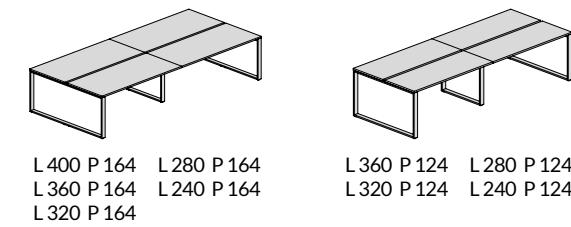

Melaminico | Melamine | Mélamine

N3BD 25	Bianco Dance White Dance Blanc Dance	N2GN 25	Grigio Nuvola Cloud Grey Nuage Gris	N2AN 25	Acero Nordic Nordic Maple Érable Nordici	N3RT 25	Rovere Twist Durmast Twist Chêne Twist
N2NO 25	Noce Walnut Noyer	N3RV 25	Rovere Oak Chêne	N3NA 25	Noce Napoli Walnut Napoli Noyer Napoli	N2GF 25	Grigio Fango Mud Grey Gris Boue
N3NJ 25	Nero Jazz Black Jazz Noir Jazz						

Scrivanie e bench in vetro | Desks and front to front desks in glass | Bureaux et bureaux opposés en verre

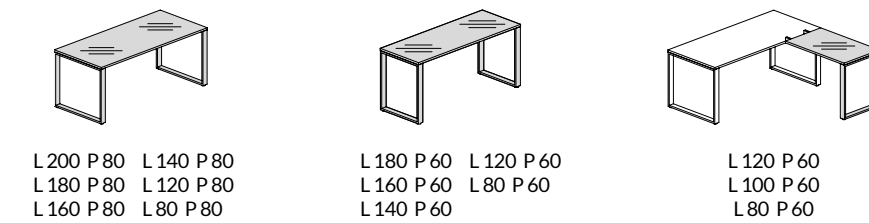

Metallo | Metal | Métal

M2BD	Bianco Dance White Dance Blanc Dance	M1NE	Nero Elegante Smart Black Noir Éléгант	M2AG	Alluminio Goffrato Embossed Metal Alu Aluminium Gauffré
------	--	------	--	------	---

Composizioni con contenitori filo-piano | Connection with desk height containers | Composition avec armoires hauteur bureau

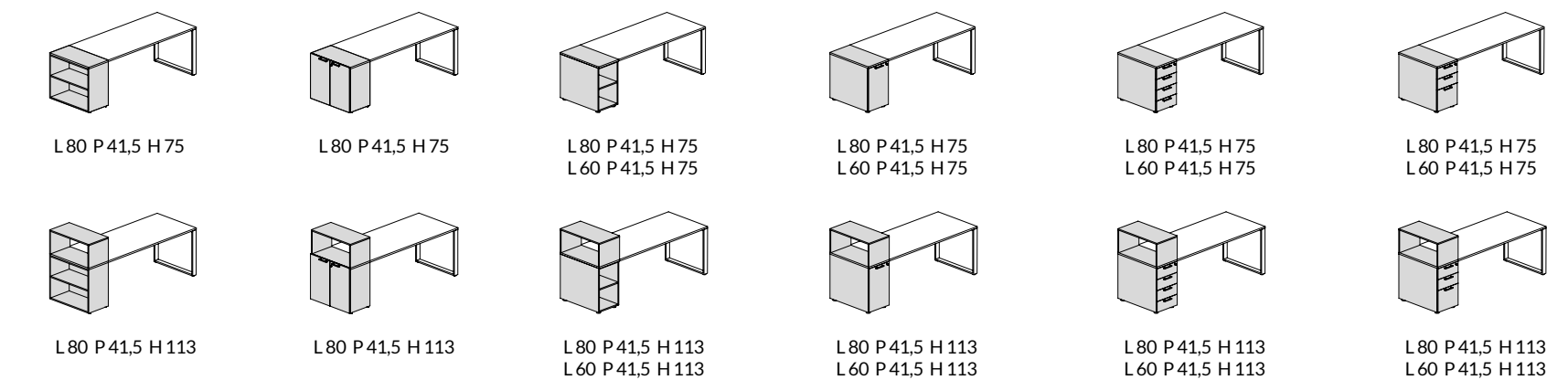

Vetro | Glass | Verre

E1BD	Bianco Dance White Dance Blanc Dance	E1GY	Grigio Yoga Yoga Grey Gris Yoga	V1NE	Nero Elegante Smart Black Noir Éléгант	E1TT	Titanio Titanium Titane
E1GF	Grigio Fango Mud Grey Gris Boue	V1BV	Blu Vivo Sparkling Blue Blue Brillant	E1MS	Marsala Marsala Marsala	V1MK	Moka Moka Moka
E1DE	Denim Denim Denim	E1VF	Verde Foresta Forest Green Forêt verte				

Tutti i componenti si integrano tra loro con armonia combinando le finiture in melaminico e le superfici in vetro con il metallo della struttura.

All components can be integrated perfectly with each other, combining melamine finishes and glass surfaces with the metal of the structure.

Tous les éléments s'intègrent harmonieusement les uns aux autres, alliant les finitions en mélaminé et les surfaces en verre avec le métal de la structure.

Gamba U

U Leg

Piètement à U

Minimal, ma significativa.

Dalla struttura metallica pura ed essenziale della gamba U si genera una postazione lavorativa d'impatto. Libertà di espressione con diverse combinazioni cromatiche e materiche delle superfici. L'ufficio prende vita e risponde a tutti gli impieghi richiesti.

Minimalist, but significant.

The pure and essential lines of the U leg metal structure generate a workstation with a forceful character. Freedom of expression with different combinations of surface colours and materials. The office comes to life and successfully meets every work requirement.

Minimal, mais significative.

La structure métallique pure et essentielle du piètement à U permet d'obtenir un poste de travail d'impact. Liberté d'expression avec différentes combinaisons chromatiques et matérielles des surfaces. Le bureau prend vie et répond à toutes les utilisations demandées.

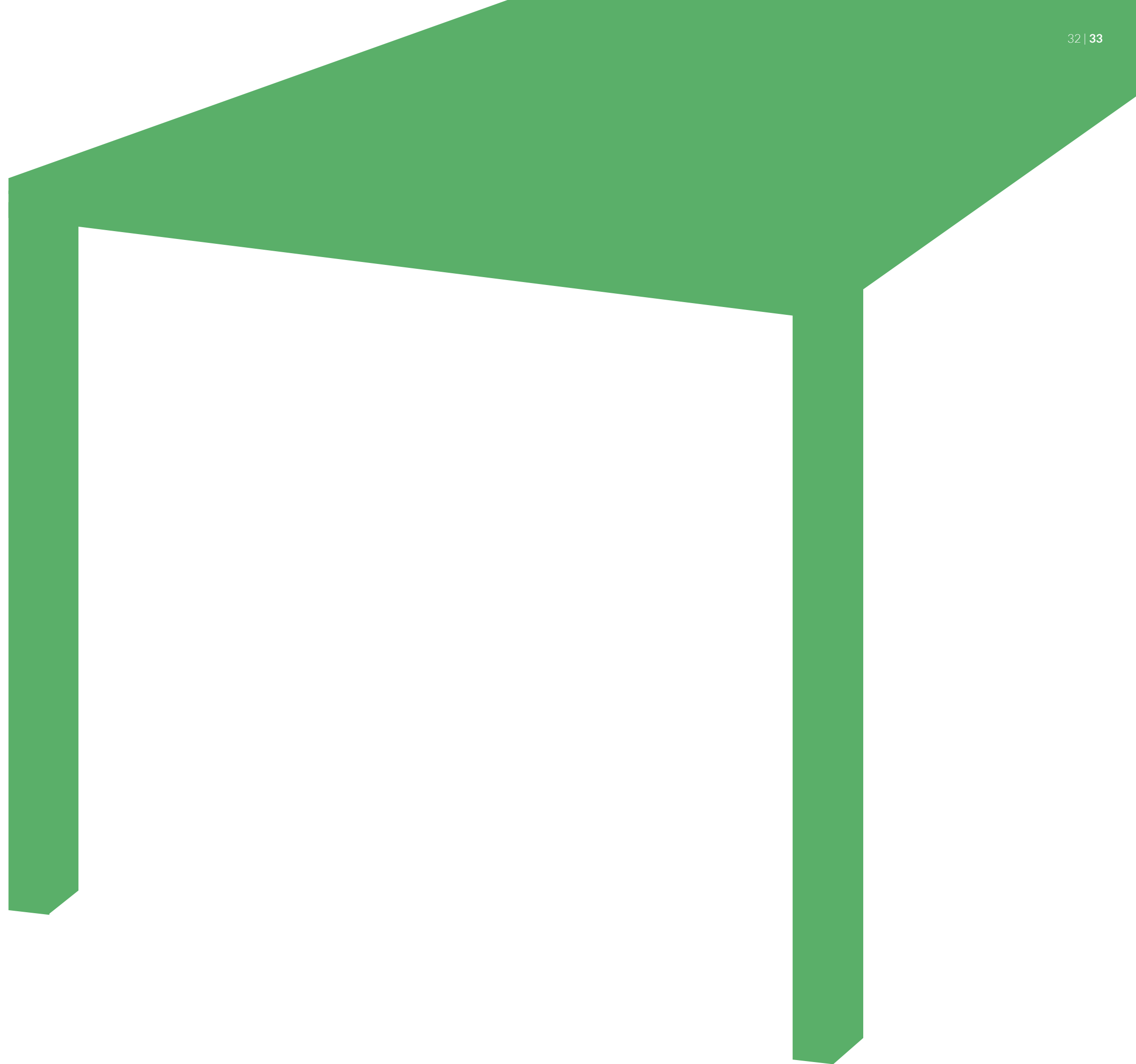



La possibilità di scelta tra piano di lavoro in melaminico o vetro caratterizza l'ambiente ufficio con due stili completamente diversi.

The choice of work surfaces in melamine or glass is a feature of this office environment with two completely different styles.

La possibilité de choisir entre un plateau en mélaminé ou un plateau en verre caractérise l'environnement professionnel avec deux styles complètement différents.







Il tavolo quadrato riformula la tradizionale sala riunione; dimensioni ottimali per ricavare un'area meeting nello spazio condiviso con le postazioni operative.

The square table redesigns the traditional meeting room; optimum dimensions to create a meeting area in the space shared with the operative workstations.

La table carrée redéfinit la salle de réunion traditionnelle avec ses dimensions optimales pour créer une zone de réunion dans l'espace partagé avec les bureaux opérationnels.







Scegliere un mobile di servizio di supporto al piano di lavoro è il giusto compromesso tra funzionalità e uno spazio ridotto; la componibilità dei moduli consente di individuare la soluzione più adatta alle proprie esigenze.

Choosing a service furniture unit supporting the worktop is the right compromise between functionality and optimization of space; the system modularity allows you to find the solution that best suits your needs.

Choisir un meuble de service comme soutien d'un plateau est le juste compromis entre fonctionnalité et espace réduit. De plus, la flexibilité des modules permet d'identifier la solution la plus adaptée aux différents besoins.



Le postazioni bench permettono di ospitare capienti mobili di servizio, freestanding o portanti, posizionandoli sotto il piano di lavoro.

Workbench solutions allow you to accommodate spacious, free-standing or supporting service units, placed under the worktop.

Les postes bench permettent d'installer de grands meubles de service, porteurs ou indépendants, en les disposant sous le plan de travail.





Totale condivisione degli spazi e massima libertà di movimento grazie alla componibilità delle postazioni di lavoro frontali con gamba U condivisa e gamba anello centrale.

Total space sharing and maximum freedom of movement thanks to the modularity of front to front workstations with shared U leg and a central ring leg.

Partage total des espaces et liberté de mouvement maximale grâce à la modularité des postes de travail frontaux avec piètement à U partagé et à piètement en forme d'anneau central.



Gli schermi divisorii in melaminico risultano indispensabili per conferire il giusto livello di privacy a postazioni di lavoro contrapposte.

The melamine partition screens are essential to give the right level of privacy to front to front workstations.

Les écrans de séparation en mélaminé sont indispensables pour offrir le niveau de confidentialité adéquat aux postes de travail opposés.





Le diverse combinazioni cromatiche delle finiture catturano lo sguardo e vivacizzano i contenitori modulari Lockers in modo accattivante.

The various colour combinations of the finishes are eye-catching, adding a visually appealing liveliness to the Lockers modular storage units.

Les différentes combinaisons chromatiques des finitions attirent le regard et dynamisent les modules Lockers de manière captivante.



I mobili filo piano si integrano alla scrivania fungendo sia da pratici contenitori che da moduli a giorno ideali per suddividere le postazioni; connubio ottimale di archiviazione e privacy.

The desk height units fit in excellently with the desk, providing practical storage units and open shelving creating useful partitions; an ideal combination of personal storage and privacy.

Les meubles hauteur bureau s'intègrent au bureau en tant que meubles de rangement pratiques ou modules à jour, parfaits pour diviser les postes, dans une fusion optimale de l'archivage et du respect de la vie privée.





Ambienti ufficio completi e funzionali grazie alla possibilità di combinare scrivanie, contenitori e tavoli riunione con finiture e materiali diversi ma del tutto abbinabili.

Perfectly functional office environments thanks to the possibility of combining desks, storage units and meeting tables with various, fully matching finishes and materials.

Espaces de bureau complets et fonctionnels grâce à la possibilité de combiner des bureaux, des meubles de rangement et des tables de réunion avec des finitions et des matériaux divers, mais entièrement associables.

La gamba U propone numerose soluzioni per lo spazio riunione, tutte caratterizzate da linee rigorose e pulite in grado di valorizzare l'ambiente.

The U leg structure offers several solutions for the meeting area, all featuring clean, rigorous lines that can greatly enhance the environment.

Le piètement à U offre de nombreuses solutions pour l'espace réunion, toutes caractérisées par des lignes rigoureuses et nettes, permettant de mettre l'environnement en valeur.





L'estensione longitudinale di bench e scrivanie in appoggio su mobili di servizio dà forma a composizioni dinamiche, creando ambienti di lavoro funzionali e confortevoli.

The longitudinal extension of the work bench and desks connected to the service units gives shape to dynamic compositions, creating functional and comfortable work environments.



L'extension longitudinale du poste bench et des bureaux en appui sur les meubles de service donne forme à des compositions dynamiques, créant des cadres de travail fonctionnels et confortables.





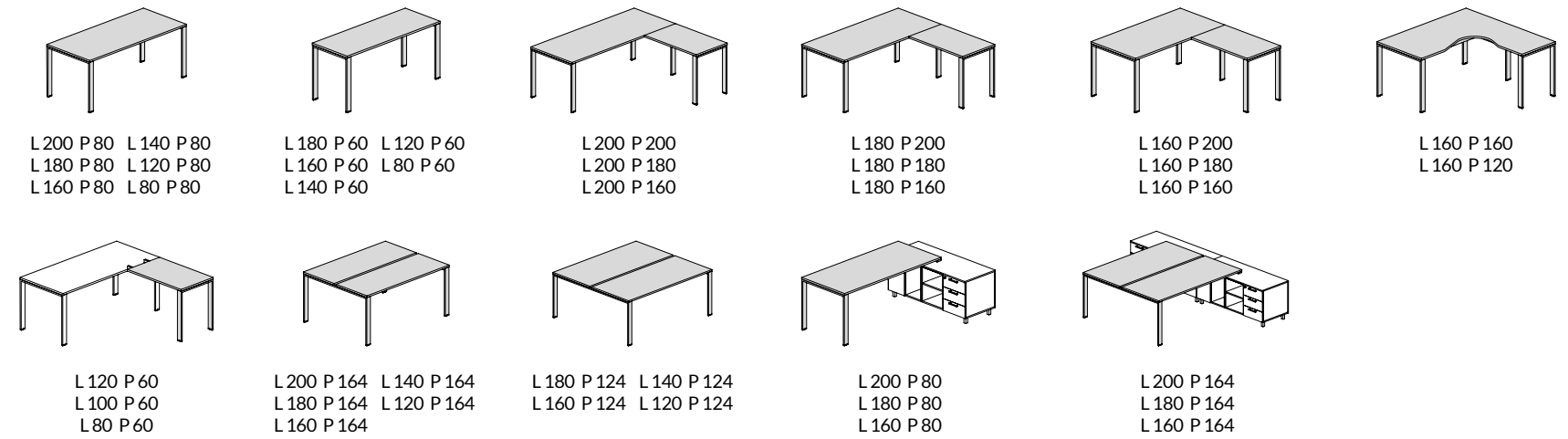

Tavoli riunione in melaminico | MFC Meeting Tables | Tables de Réunion en mélaminé

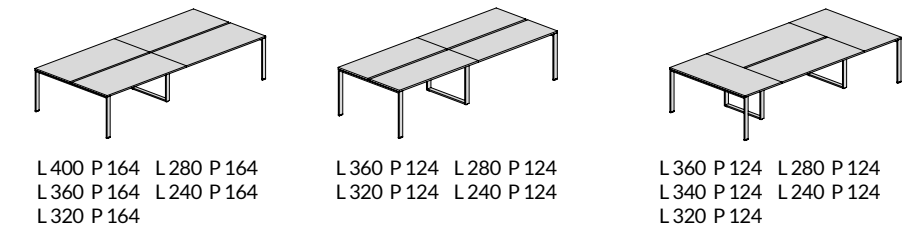

Scrivanie e bench in vetro | Desks and front to front desks in glass | Bureaux et bureaux opposés en verre

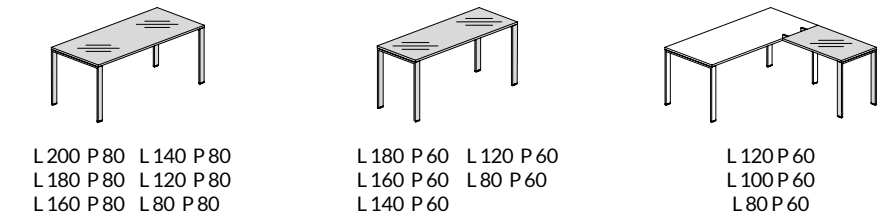

Tavoli riunione in vetro | Glass Meeting Tables | Tables de Réunion en verre

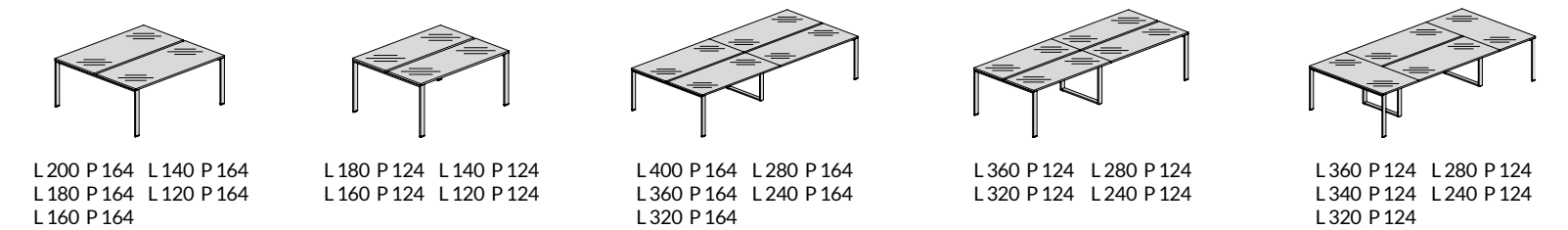

Composizioni con contenitori filo-piano | Connection with desk height containers | Composition avec armoires hauteur bureau

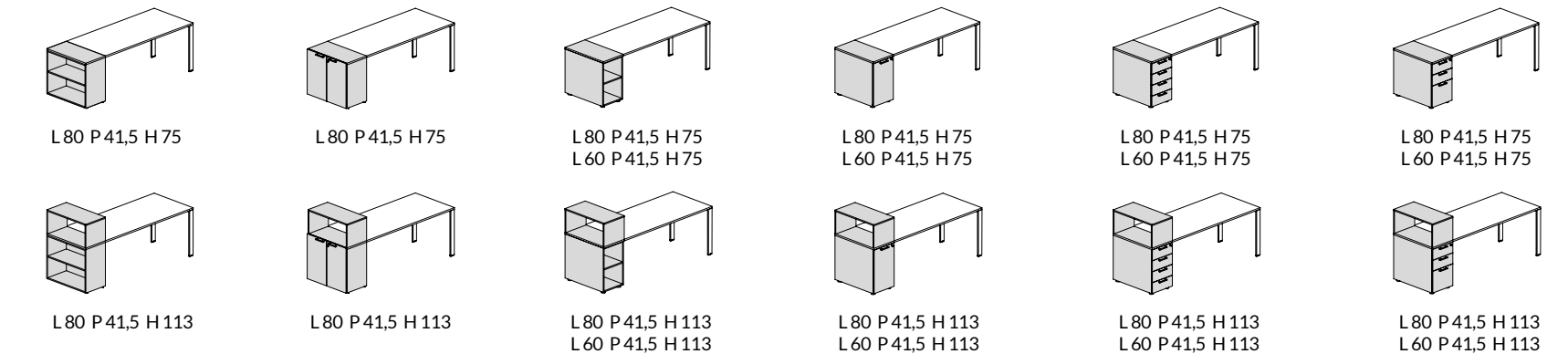

L'estetica dell'ambiente lavorativo soddisferà ogni tipo di gusto con i diversi accostamenti realizzabili tra le finiture cromatiche e i materiali ricercati.

The visual appeal of this work environment will suit all tastes with various combinations that can be achieved with various colour finishes and refined materials.

L'esthétique de l'environnement de travail sera en mesure de répondre à tous les types de style, avec différentes associations réalisables entre les finitions chromatiques et les matériaux recherchés.

Melaminico | Melamine | Mélamine

N3BD	Bianco Dance White Dance Blanc Dance	25	N2GN	Grigio Nuvola Cloud Grey Nuage Gris	25	N2AN	Acero Nordic Nordic Maple Érable Nordic	25	N3RT	Rovere Twist Durmast Twist Chêne Twist	25
N2NO	Noce Walnut Noyer	25	N3RV	Rovere Oak Chêne	25	N3NA	Noce Napoli Walnut Napoli Noyer Napoli	25	N2GF	Grigio Fango Mud Grey Gris Boue	25
N3NJ	Nero Jazz Black Jazz Noir Jazz	25									

Metallo | Metal | Métal

M2BD	Bianco Dance White Dance Blanc Dance	M1NE	Nero Elegante Smart Black Noir Éléphant	M2AG	Alluminio Goffrato Embossed Metal Alu Aluminium Gauffré
------	--	------	---	------	---

Vetro | Glass | Verre

E1BD	Bianco Dance White Dance Blanc Dance	E1GY	Grigio Yoga Yoga Grey Gris Yoga	V1NE	Nero Elegante Smart Black Noir Éléphant	E1TT	Titanio Titanium Titane
E1GF	Grigio Fango Mud Grey Gris Boue	V1BV	Blu Vivo Sparkling Blue Blue Brillant	E1MS	Marsala Marsala Marsala	V1MK	Moka Moka Moka
E1DE	Denim Denim Denim	E1VF	Verde Foresta Forest Green Forêt verte				

Fianco Legno

Wood Side

Côté Bois

La superficie classica e rigorosa del fianco legno è il segreto per un'estetica sempre attuale ed estremamente elegante. Il design pratico ed ergonomico soddisfa tutte le esigenze dell'ufficio operativo e dà vita a una scrivania lineare dalla capacità compositiva infinita.

The classic and rigorous surface of Wood Side is the secret of its timeless and extremely elegant visual appeal. The practical and ergonomic design meets all operative office requirements and creates a linear desk with infinite possibilities of combinations.

La surface classique et rigoureuse du côté bois est le secret d'une esthétique toujours actuelle et résolument élégante. Le design pratique et ergonomique répond à tous les besoins du bureau opérationnel et donne vie à un bureau linéaire aux capacités de composition infinies.





Comodità e contemporaneità si coniugano con i volumi e con le superfici composte, affiancando alla scrivania un mobile di servizio indipendente.

Comfort and contemporary design blend nicely with the volumes and composite surfaces, providing the desk with an independent service unit.

Confort et modernité se conjuguent avec les volumes et les surfaces composées, associant au bureau un meuble de service indépendant.





L'innovativa finitura Rovere realizzata con un melaminico di ultima generazione si sposa alla perfezione con le superfici bianche dei mobili d'archivio.

The innovative Oak finish made with latest-generation melamine goes perfectly with the white surfaces of shelving units.

La finition Chêne, réalisée avec un mélaminé de dernière génération, épouse à la perfection les surfaces blanches des meubles d'archivage.



Scrivania ampia, ma compatta. Lo spazio di lavoro non ha limiti di progettazione, grazie agli allunghi complanari dall'elevato rigore funzionale.

Ample-sized, yet compact desk. The workspace has a limitless design, thanks to the desk height extensions with their highly functional rigour.

Un bureau large, mais compact. L'espace de travail n'a aucune limite de conception grâce aux retours coplanaires à forte rigueur fonctionnelle.



Un bureau large, mais compact. L'espace de travail n'a aucune limite de conception grâce aux retours coplanaires à forte rigueur fonctionnelle.





Massima efficienza tecnologica con il sistema di passaggio cavi, indispensabile per una postazione di lavoro pratica e confortevole.

The utmost in technological efficiency with the integrated cable grommet, which is essential for a practical and comfortable workstation.

Efficacité technologique maximale avec le système de passage de câbles, indispensable pour un poste de travail pratique et confortable.



Mobili pensati per modellare l'ambiente lavorativo quotidiano e renderlo personalizzato, come il mobile contenitore con moduli a giorno e ad anta in melaminico.

Furniture units designed to shape the daily work environment with customised features such as the storage cabinet with open units and those with melamine doors.

Meubles conçus pour façonner l'environnement professionnel quotidien et le personnaliser, comme le meuble de rangement à modules à jour et avec porte en mélaminé.





Diverse tipologie di mobili a filo piano per comporre infinite soluzioni d'arredo, volte alla produttività e al benessere nell'ambiente di lavoro.

Various kinds of desk height units to compose an infinite number of furnishing solutions, aimed at productivity and well-being in the work environment.

Différents types de meubles hauteur bureau pour composer des solutions d'ameublement infinies, destinées à la productivité et au bien-être dans le cadre professionnel.



Un gusto lievemente retrò, ma dal design originale e senza tempo: piano compatto e raccordo a 90° donano uno stile inconfondibile.

A slightly "retro" style, but with an original and timeless design: a compact top and 90° linking element afford a unique style.

Un style légèrement rétro, mais au design original et intemporel : le plan compact et le raccord à 90° offrent un style incomparable.



La classica finitura in noce rappresenta una scelta originale per conferire allo spazio operativo una forte caratterizzazione e un'aura di calore e luminosità.

The classic walnut finish is an original choice that gives the operative space a powerful character and an aura of warmth and brightness.

La finition classique en noyer représente un choix original, conférant à l'espace opérationnel un caractère fort et une aura de chaleur et de luminosité.





La scrivania Fianco Legno dispone di due diverse dimensioni di fianco. La profondità di 57 cm dona una estetica più classica e tradizionale.

The Wood Side desk has two different sizes for the side panels. The 57 cm version gives a more classic and traditional esthetics.

Le bureau Côté bois possède deux dimensions latérales différentes. La profondeur de 57 cm offre une esthétique plus classique et traditionnelle.



La profondità di 80 cm è caratterizzata da una linea unica e minimalista per un ambiente professionale e di alta classe.

The 80 cm version is characterised by a unique and minimalist line for a professional, high class setting.

La profondeur de 80 cm se caractérise par une ligne unique et minimaliste pour un environnement professionnel haut de gamme.



Configurazioni originali, sia singole che aggregate, accostando le postazioni e mantenendo discrezione con l'inserimento di schermi fonoassorbenti, in melaminico o acrilici.

Original, individual or group-based compositions, bringing work places together while maintaining discretion through the use of screens, sound absorbing, in melamine or acrylic.

Les configurations originales, simples et jointes, permettent d'associer les postes et de garantir la discrétion en ajoutant des écrans acoustiques, en mélaminé ou en acryliques.







Scrivanie | Desks | Bureaux

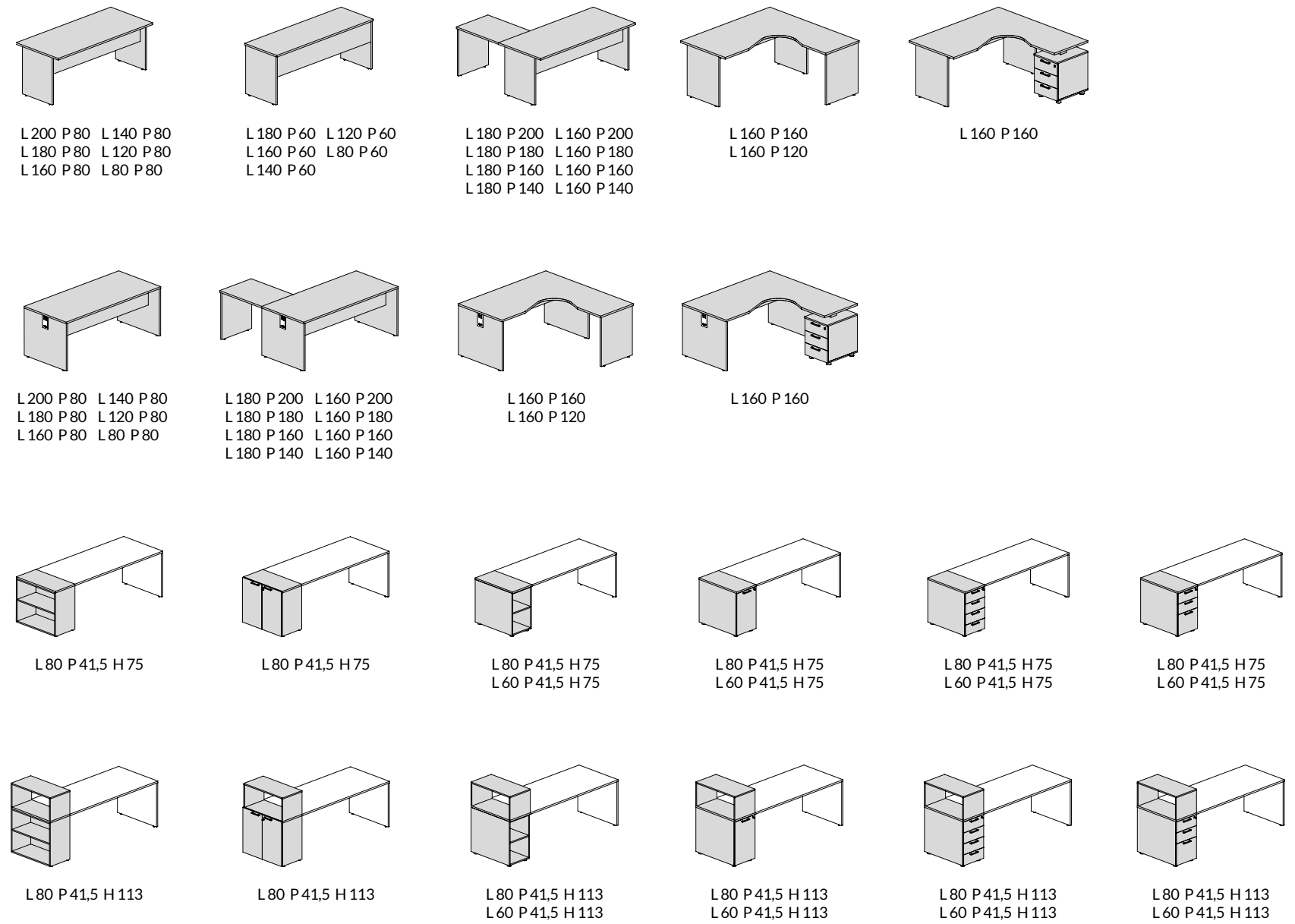

Melaminico | Melamine | Mélamine

N3BD 25	Bianco Dance White Dance Blanc Dance	N2GN 25	Grigio Nuvola Cloud Grey Nuage Gris	N2AN 25	Acero Nordic Nordic Maple Érable Nordic	N3RT 25	Rovere Twist Durmast Twist Chêne Twist
N2NO 25	Noce Walnut Noyer	N3RV 25	Rovere Oak Chêne	N3NA 25	Noce Napoli Walnut Napoli Noyer Napoli	N2GF 25	Grigio Fango Mud Grey Gris Boue
N3NJ 25	Nero Jazz Black Jazz Noir Jazz						

Tavoli Riunioni | Meeting Tables | Tables de Réunion

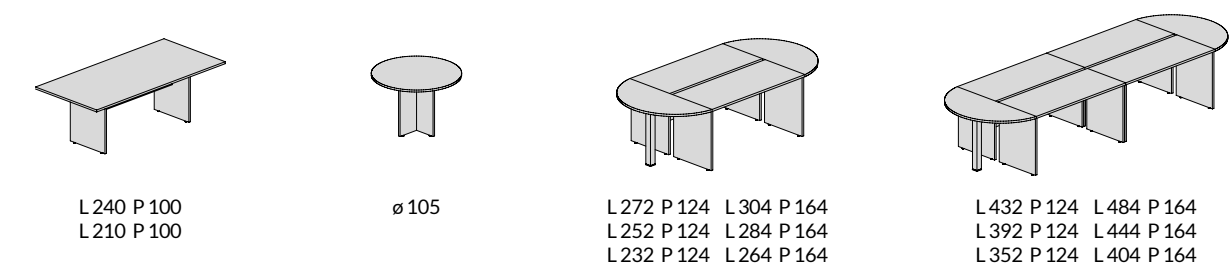

Grande gioco di abbinamenti cromatici e materici con l'ampia scelta di finiture in melaminico per le scrivanie, da affiancare ai numerosi complementi della collezione.

A large, playful mix of matching colours and materials with a wide selection of melamine finishes for the desks, to be accompanied by numerous complementary items in the collection.

Grand jeu d'associations chromatiques et matérielles avec le vaste choix de finitions en mélaminé pour les bureaux, à assortir aux nombreux compléments de la collection.

Gamba Csquare

Csquare Leg

Piètement à Csquare

L'innovazione si traduce in una struttura metallica originale e asimmetrica, disegnata rispettando la semplicità delle forme e la facilità di assemblaggio. Un design capace di dar vita a uno spazio professionale curandolo fino al minimo dettaglio grazie alle unioni armoniche tra i diversi materiali e colori.

Innovation is the theme conveyed by this original and asymmetrical metal structure with its simply shaped design and easy assembly. A design that can give life to a professional space, with the utmost care right down to the last detail, thanks to the harmonious blends between various materials and colours.

L'innovation se traduit par une structure métallique originale et asymétrique, conçue en respectant la simplicité des formes et la facilité de montage. Un design capable de donner vie à un espace professionnel, le soignant dans les moindres détails grâce aux mariages harmonieux entre les différents matériaux et coloris.

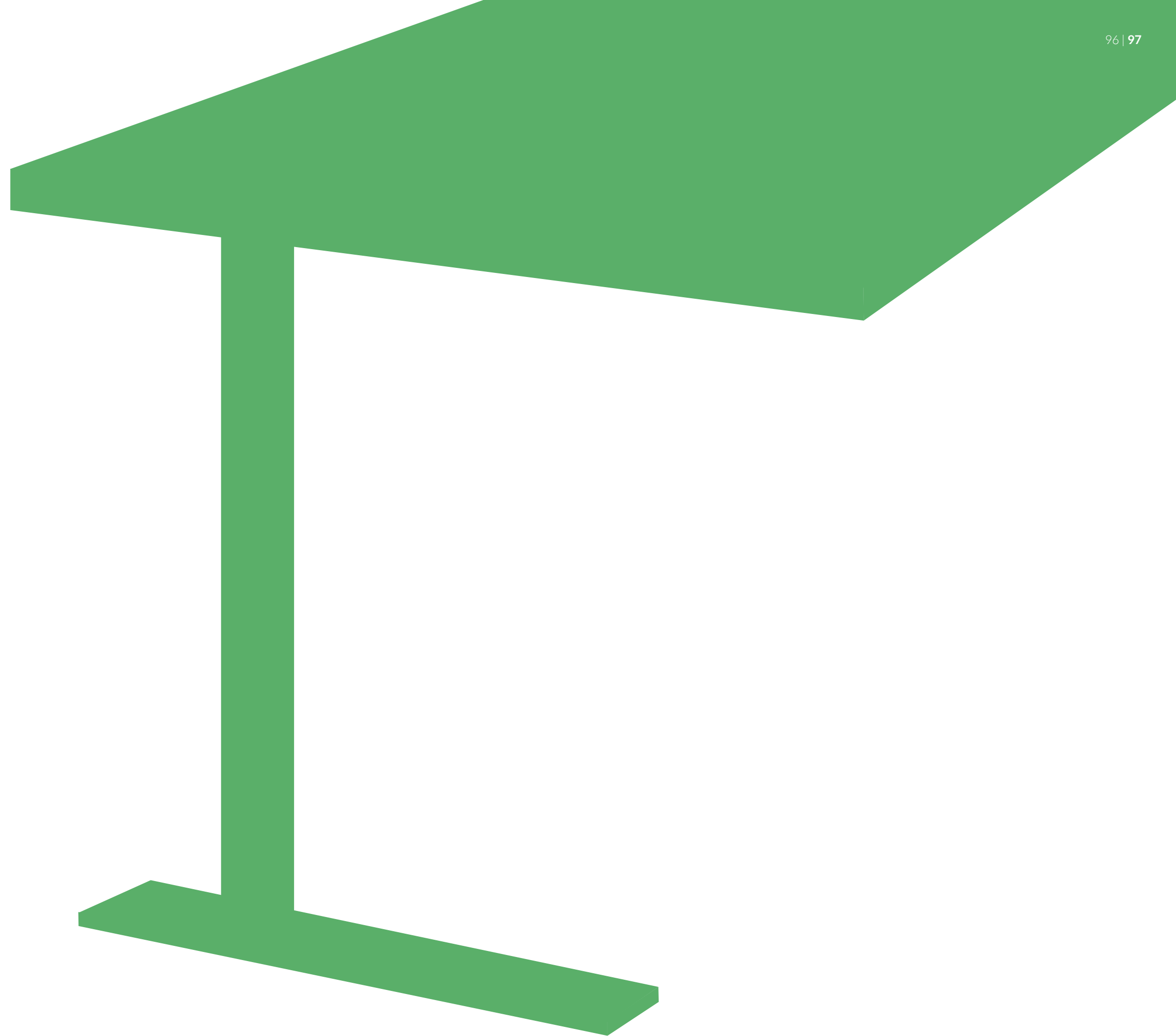



La postazione di lavoro con gamba Csquare sintetizza linearità e modernità per generare un ambiente attuale e dinamico.

The workstation with Csquare leg is the epitome of linearity and modernity to create a contemporary and dynamic environment.

Le poste de travail à piètement Csquare synthétise la linéarité et la modernité pour créer un environnement actuel et dynamique.





Le combinazioni di bench e mobili di contenimento, filo-piano o di servizio, rendono le postazioni ampie e dotate di ogni comfort.

The combinations of workbenches with desk height personal storage units, or service units generate spacious workstations equipped with every comfort.

Les combinaisons du poste bench et de meubles de rangement, hauteur bureau ou de service, rendent les postes spacieux et résolument confortables.



The combinations of workbenches with desk height personal storage units, or service units generate spacious workstations equipped with every comfort.





Allunghi e piani compatti sono la soluzione che permette di ampliare la superficie di lavoro in modo razionale e funzionale.

Desk extensions and compact tops provide the perfect solution for expanding work surfaces in a rational and functional manner.

Retours et plateaux compacts sont la solution qui permet d'augmenter la surface de travail de manière rationnelle et fonctionnelle.





Postazioni ideali per spazi co-working: piena libertà di composizione e massima funzionalità.

Perfect workstations for co-working spaces: absolute freedom of composition and maximum functionality.

Postes idéaux pour les espaces de coworking : pleine liberté de composition et fonctionnalité maximale.



I raccordi a 90° consentono di comporre tavoli riunione dalla superficie continua ed estremamente elegante.

The 90° linking elements sections allow the creation of meeting tables with a seamless and extremely elegant work surface.

Les raccords à 90° permettent de composer des tables de réunion à la surface continue et très élégante.





Scrivanie | Desks | Bureaux

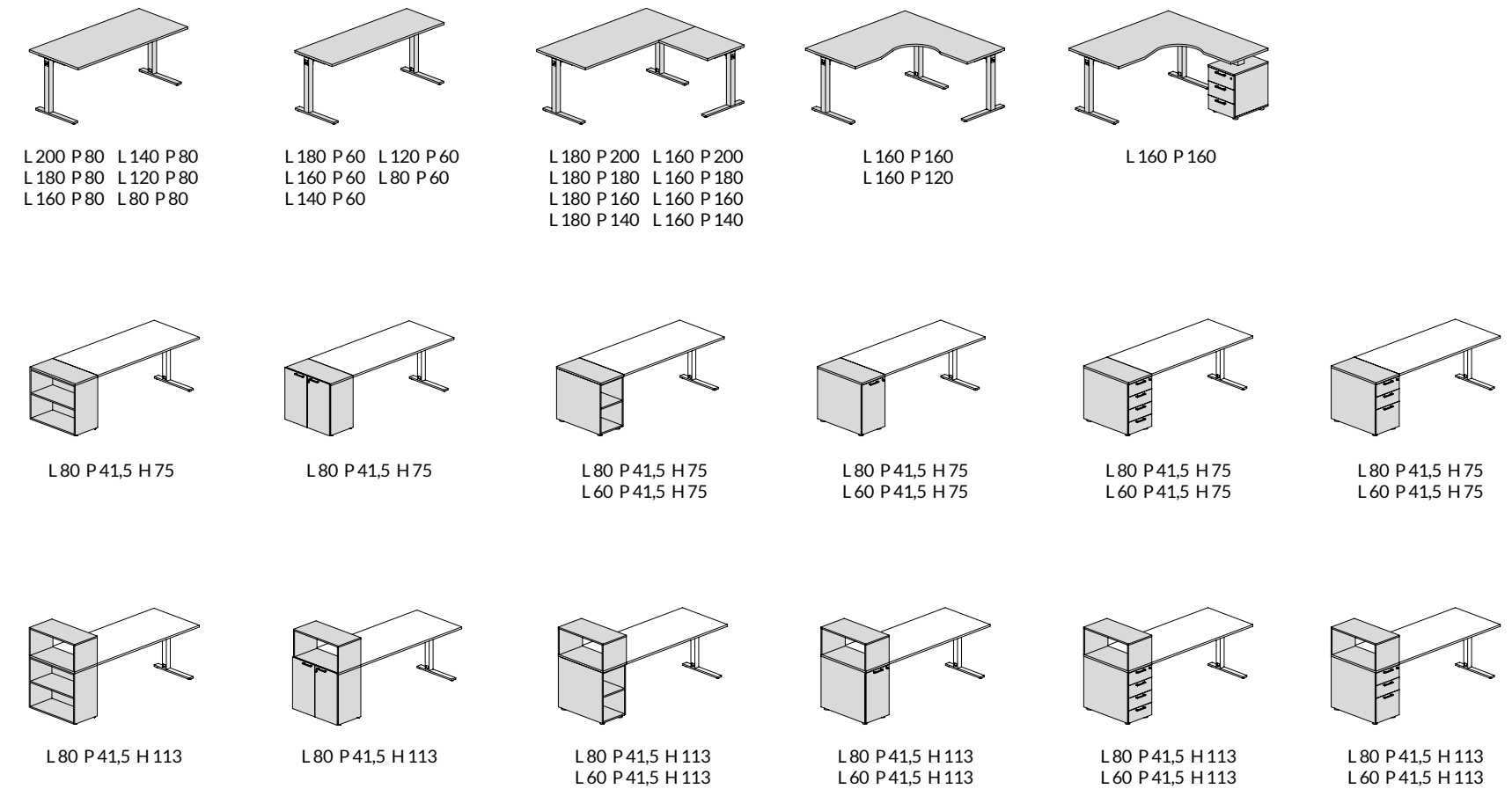

L 200 P 80 L 140 P 80
L 180 P 80 L 120 P 80
L 160 P 80 L 80 P 80

L 180 P 60 L 120 P 60
L 160 P 60 L 80 P 60
L 140 P 60

L 180 P 200 L 160 P 200
L 180 P 180 L 160 P 180
L 180 P 160 L 160 P 160
L 180 P 140 L 160 P 140

L 160 P 160
L 160 P 120

L 160 P 160

L 80 P 41,5 H 75

L 80 P 41,5 H 75

L 80 P 41,5 H 75
L 60 P 41,5 H 75

L 80 P 41,5 H 75
L 60 P 41,5 H 75

L 80 P 41,5 H 75
L 60 P 41,5 H 75

L 80 P 41,5 H 75
L 60 P 41,5 H 75

L 80 P 41,5 H 113

L 80 P 41,5 H 113

L 80 P 41,5 H 113
L 60 P 41,5 H 113

L 80 P 41,5 H 113
L 60 P 41,5 H 113

L 80 P 41,5 H 113
L 60 P 41,5 H 113

L 80 P 41,5 H 113
L 60 P 41,5 H 113

Melaminico | Melamine | Mélamine

N3BD 25	Bianco Dance White Dance Blanc Dance	N2GN 25	Grigio Nuvola Cloud Grey Nuage Gris	N2AN 25	Acero Nordic Nordic Maple Érable Nordic	N3RT 25	Rovere Twist Durmast Twist Chêne Twist
N2NO 25	Noce Walnut Noyer	N3RV 25	Rovere Oak Chêne	N3NA 25	Noce Napoli Walnut Napoli Noyer Napoli	N2GF 25	Grigio Fango Mud Grey Gris Boue
N3NJ 25	Nero Jazz Black Jazz Noir Jazz						

Tavoli Riunioni | Meeting Tables | Tables de Réunion

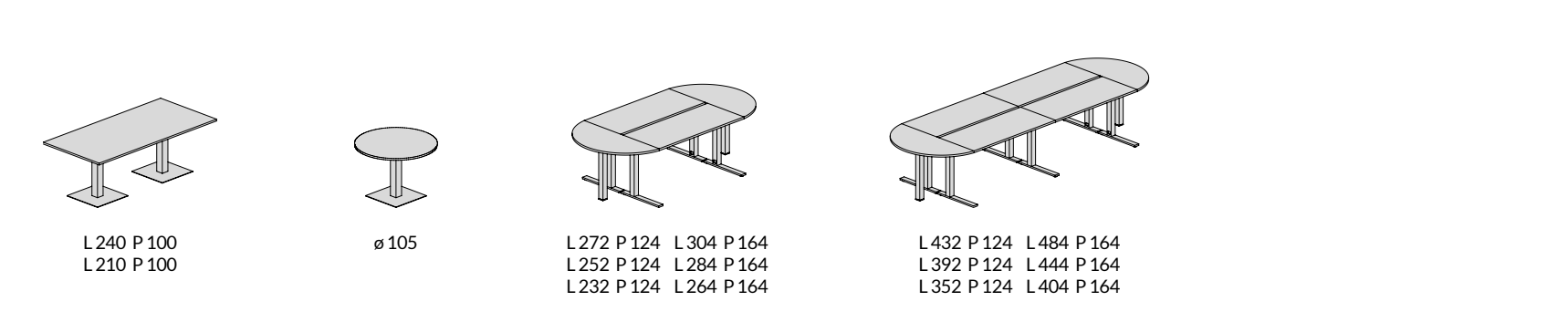

L 240 P 100
L 210 P 100

ø 105

L 272 P 124 L 304 P 164
L 252 P 124 L 284 P 164
L 232 P 124 L 264 P 164

L 432 P 124 L 484 P 164
L 392 P 124 L 444 P 164
L 352 P 124 L 404 P 164

Metallo | Metal | Métal

M2BD	Bianco Dance White Dance Blanc Dance	M1NE	Nero Elegante Smart Black Noir Éléphant	M2AG	Alluminio Goffrato Embossed Metal Alu Aluminium Gauffré
------	--	------	---	------	---

Lo stile unico della gamba Csquare è il risultato delle combinazioni tra i materiali e le finiture per il piano di lavoro e la struttura.

The unique style of the Csquare leg is the result of all the combinations created with materials and finishes for the worktop and structure.

Le style unique du piètement Csquare est le résultat des combinaisons entre les matériaux et les finitions du plan de travail et de la structure.

Gamba Tsquare

Tsquare Leg

Piètement à Tsquare

Composizioni leggere e facili da assemblare, dotate di una struttura metallica originale e di piani dalle proporzioni e i dettagli accurati. Possibilità aggiuntiva di alloggiare i cavi dell'elettrificazione in maniera smart e versatile.

Light compositions and easy to assemble, consisting of an original metal structure and tops with careful proportions and details. An additional feature allows you to accommodate the cable management in a smart and versatile manner.

Compositions légères et faciles à monter, munies d'une structure métallique originale et de plans aux proportions et détails soignés. Possibilité supplémentaire d'ajouter les câbles électriques de manière intelligente et polyvalente.





Una scrivania dalla struttura solida, seppur delicata e snella, e con piano di lavoro e gonna della medesima finitura per un'idea di continuità e classe.

A desk with a solid structure, yet delicate and slender, and with the worktop and modesty panel of the same finish for an idea of continuity and class.

Un bureau avec une structure solide, bien que délicate et mince, et doté d'un plan de travail et d'une voile de fond de la même finition, pour une notion de continuité et de classe.









Innovazione e design nel nuovo sistema di contenimento Lockers, con serratura standard o con combinazione, per il massimo della protezione e della privacy.

Innovation and design in the new Lockers storage system, with standard or combination locks, for maximum protection and privacy.

Innovation et conception du nouveau système de rangement Lockers, à serrure standard ou à combinaison, pour une protection et un respect de la vie privée maximums.



Archiviazione alla portata di tutti con i mobili di servizio componibili e modulari, configurabili secondo le proprie esigenze.

Storage for everyone with modular service units that can be configured to suit individual needs.

Archivage à la portée de tous avec les meubles de service flexibles et modulaires, pouvant être configurés selon les besoins.





Scrivanie | Desks | Bureaux

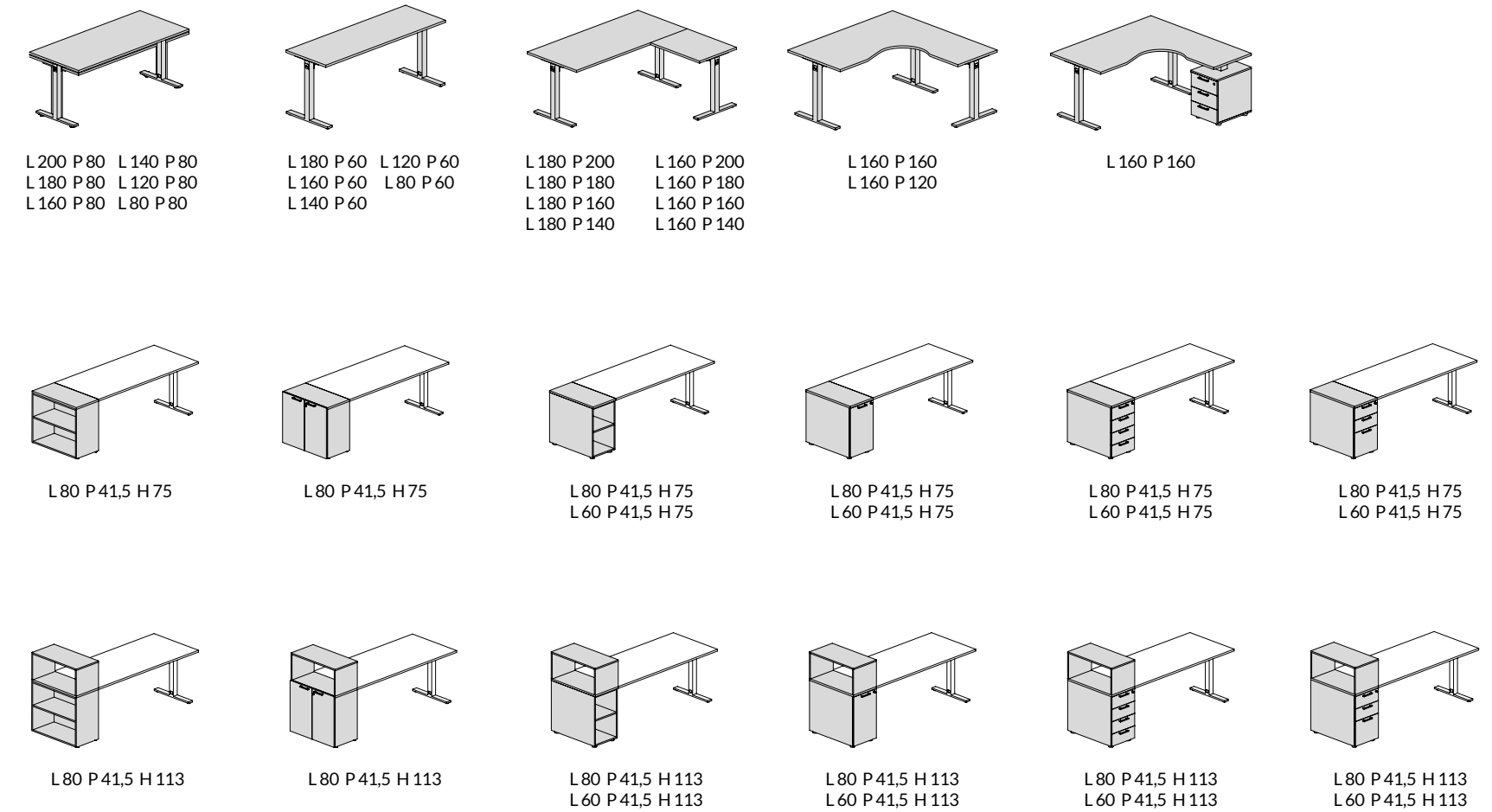

Melaminico | Melamine | Mélamine

N3BD 25	Bianco Dance White Dance Blanc Dance	N2GN 25	Grigio Nuvola Cloud Grey Nuage Gris	N2AN 25	Acero Nordic Nordic Maple Érable Nordic	N3RT 25	Rovere Twist Durmast Twist Chêne Twist
N2NO 25	Noce Walnut Noyer	N3RV 25	Rovere Oak Chêne	N3NA 25	Noce Napoli Walnut Napoli Noyer Napoli	N2GF 25	Grigio Fango Mud Grey Gris Boue
N3NJ 25	Nero Jazz Black Jazz Noir Jazz						

Metallo | Metal | Métal

M2BD	Bianco Dance White Dance Blanc Dance	M1NE	Nero Elegante Smart Black Noir Éléгант	M2AG	Alluminio Goffrato Embossed Metal Alu Aluminium Gaufré
------	--	------	--	------	--

Tavoli Riunioni | Meeting Tables | Tables de Réunion

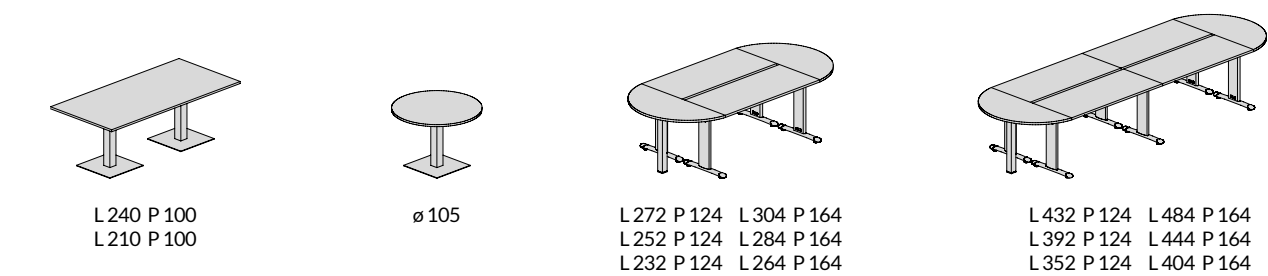

Ampia scelta di finiture dei piani in melaminico, abbinabili a tutti gli accessori ed elementi di contenimento della famiglia Funny.

Wide choice of finishes for the melamine tops, in combination with all the accessories and storage elements in the Funny family.

Vaste choix de finitions des plateaux en mélaminé, associables à tous les accessoires et éléments de rangement de la famille Funny.

Gamba T

T Leg

Piètement à T

La collezione ideale per ambienti operativi che necessitano di soluzioni immediate e versatili per il passaggio dell'elettrificazione. Grande leggerezza compositiva e piena scelta degli abbinamenti tra le superfici in melaminico e la gamba T di sostegno.

The ideal collection for working environments that require immediate, versatile solutions for cable management. Extremely light compositions and a full range of combinations with melamine surfaces and the supporting T leg.

La collection idéale pour les environnements opérationnels nécessitant des solutions immédiates et polyvalentes pour le passage de l'électricité. Grande légèreté de la composition et pleine liberté de choix des associations entre les surfaces en mélaminé et le piètement à T de soutien.

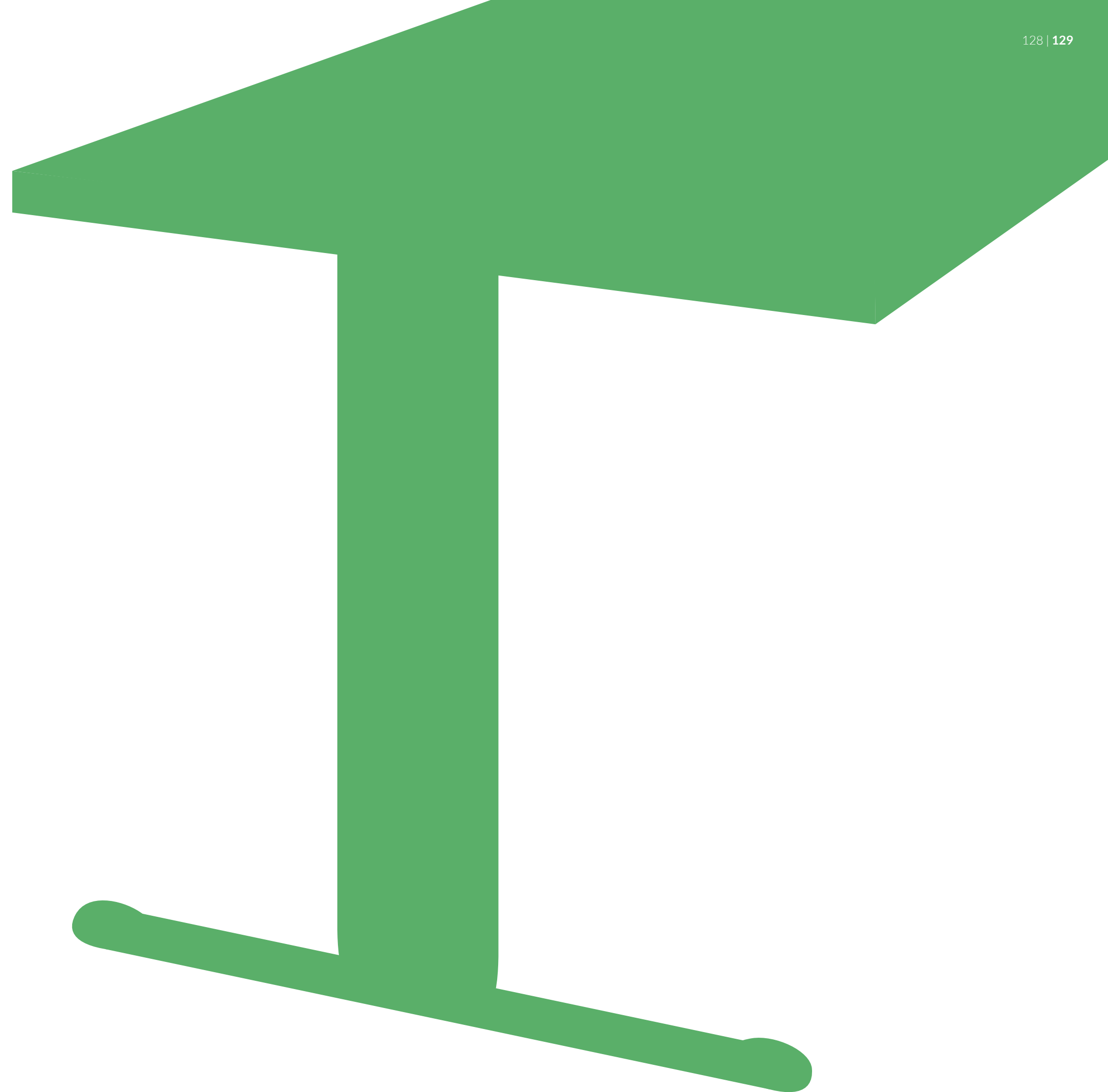



La scrivania con gamba T garantisce la massima funzionalità, ospitando il passaggio dei cavi elettrici all'interno della struttura metallica.

The desk with T leg provides maximum functionality and can accommodate cable management within the metal structure.



Le bureau avec piètement à T garantit la fonctionnalité maximale, car il permet de passer les câbles électriques dans la structure métallique.





L'archiviazione raggiunge i massimi livelli accostando al tavolo o all'allungo mobili filo-piano, disponibili in tre varianti: a giorno, con ante, con cassetti.

Highly professional personal storage solutions with desk height units next to main desk or desk extension, available in three versions: open, with doors or with drawers.

L'archivage atteint des niveaux maximums en associant à la table ou au retour des meubles hauteur bureau, qui se déclinent en trois variantes : à jour, avec porte et avec tiroirs.





Scrivanie | Desks | Bureaux

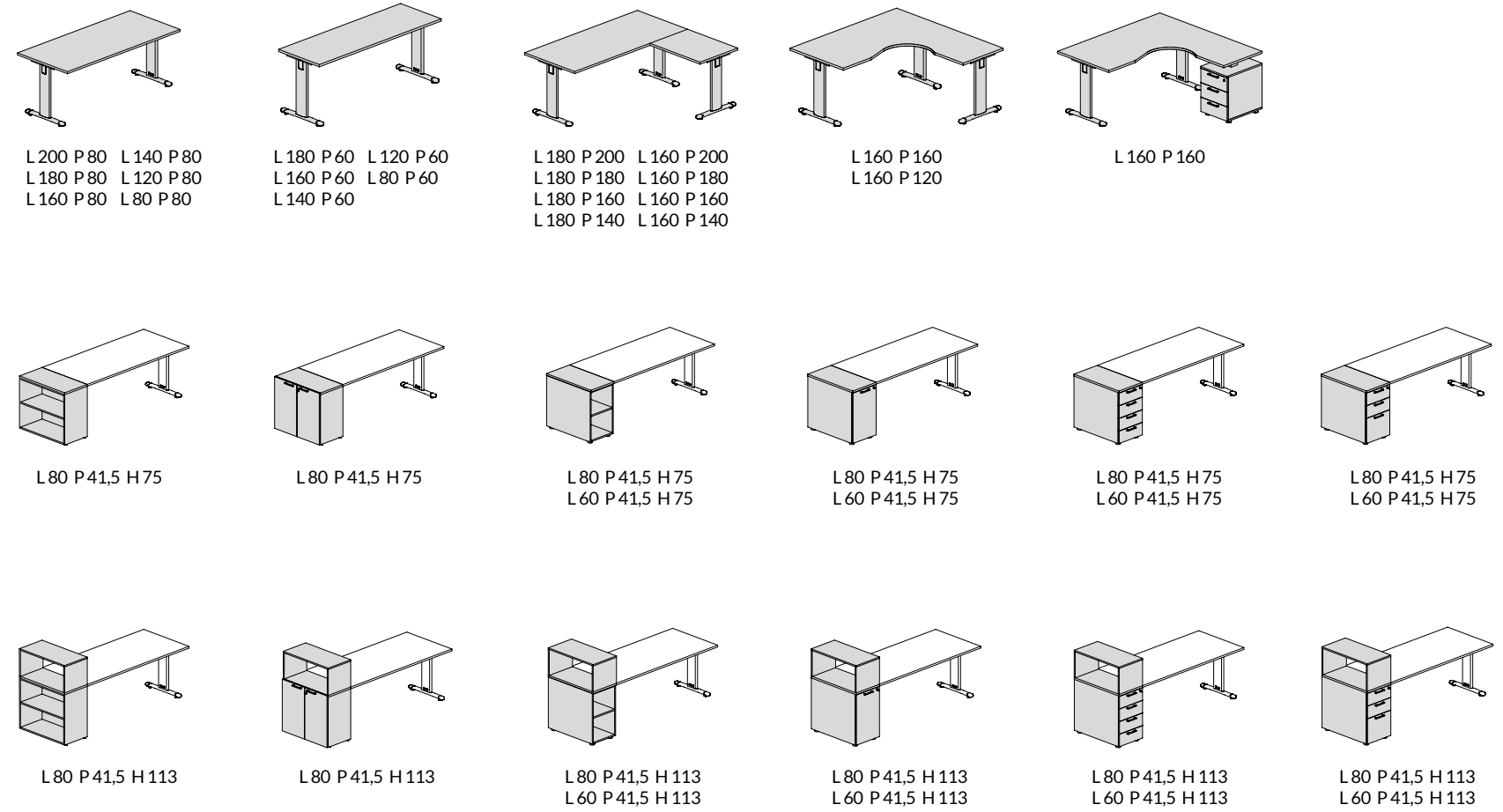

Melaminico | Melamine | Mélamine

N3BD 25	Bianco Dance White Dance Blanc Dance	N2GN 25	Grigio Nuvola Cloud Grey Nuage Gris	N2AN 25	Acero Nordic Nordic Maple Érable Nordic	N3RT 25	Rovere Twist Durmast Twist Chêne Twist
N2NO 25	Noce Walnut Noyer	N3RV 25	Rovere Oak Chêne	N3NA 25	Noce Napoli Walnut Napoli Noyer Napoli	N2GF 25	Grigio Fango Mud Grey Gris Boue
N3NJ 25	Nero Jazz Black Jazz Noir Jazz						

Metallo | Metal | Métal

M2BD	Bianco Dance White Dance Blanc Dance	M2AG	Alluminio Goffrato Embossed Metal Alu Aluminium Gauffré
------	--	------	---

Tavoli Riunioni | Meeting Tables | Tables de Réunion

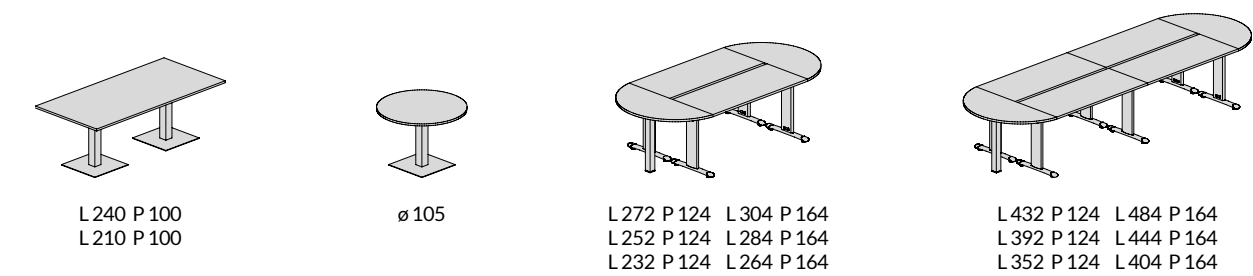

Finiture in melaminico accuratamente studiate per esprimere appieno il gusto dell'azienda e rispettare l'eleganza complessiva dell'ufficio.

Carefully researched finishes in melamine that fully express the corporate identity and respect the overall elegance of the office.

Finitions en mélaminé soigneusement étudiées pour exprimer pleinement le style de l'entreprise et pour respecter l'élégance générale du bureau.

Smart Office

Smart Office

Smart Office

Oggi gli spazi di lavoro subiscono continui mutamenti e necessitano nuove soluzioni per restare al passo con la produttività. Per questo è stata elaborata la linea Smart Office. Una serie di progetti pensati per risolvere bisogni differenti rispettando il benessere e il comfort dell'ambiente lavorativo.

Today workspaces undergo constant changes and require new solutions to keep pace with productivity. Therefore, we created the Smart Office range. A series of projects designed to address several needs while respecting the well-being and comfort in the working environment.

De nos jours, les espaces de travail subissent des évolutions constantes et exigent de nouvelles solutions pour suivre le rythme de la productivité. C'est pour cette raison que nous avons créé la ligne Smart Office. Il s'agit de plusieurs projets conçus pour répondre aux différents besoins en respectant le bien-être et le confort de l'environnement professionnel.





La postazione UP-GRADE permette di lavorare in maniera dinamica e di soddisfare le esigenze di flessibilità ed ergonomia. L'innovativo sistema sit or stand, dotato di regolazione elettrica dell'altezza del piano di lavoro, assicura massimo comfort sia da seduti, che in piedi.



The UP-GRADE workstation allows dynamic work and satisfies the requirements of flexibility and ergonomics. The innovative sit or stand system, equipped with electric height adjustment of the work surface, ensures maximum comfort when sitting or standing.

Le poste UP-GRADE permet de travailler de manière dynamique et de satisfaire les exigences en matière de flexibilité et d'ergonomie. Le système novateur Sit-Stand, équipé du réglage électrique de la hauteur du plateau de travail, assure un confort maximal assis comme debout.





Piena libertà di movimento con la scrivania T-FLEX. La postazione su ruote con piano ribaltabile è l'ideale per spazi ridotti e altamente dinamici.

Full freedom of movement with the T-FLEX desk. The workstation on castors with folding top is ideal for small and highly dynamic spaces.

Pleine liberté de mouvement avec le bureau T-FLEX. Le poste sur roulettes avec plateau pliant est la solution idéale pour les espaces réduits et hautement dynamiques.





Sistemazioni open space per call center in grado di facilitare la convivenza e rispettare la privacy individuale. Le postazioni modulari sono moltiplicabili all'infinito per un'organizzazione ottimale dello spazio.

Open space layouts for call centers created to facilitate coexistence while respecting individual privacy. The modular workstations can be multiplied to infinity allowing a highly efficient space management.

Dispositions en open space pour les centres d'appel, permettant de faciliter la cohabitation et de respecter la vie privée de chacun. Les postes modulaires peuvent être multipliés à l'infini pour une organisation optimale de l'espace.



Piani UP-grade, T-flex e Team Tables - melaminico | UP-grade, T-flex e Team Tables - MFC worktops | Plateaux UP-grade, T-flex e Team Tables - mélamine

N3BD Bianco Dance White Dance Blanc Dance	N2GN Grigio Nuvola Cloud Grey Nuage Gris	N2AN Acero Nordic Nordic Maple Érable Nordic	N3RT Rovere Twist Durmast Twist Chêne Twist	N2NO Noce Walnut Noyer
N3RV Rovere Oak Chêne	N3NA Noce Napoli Walnut Napoli Noyer Napoli	N2GF Grigio Fango Mud Grey Gris Boue	N3NJ Nero Jazz Black Jazz Noir Jazz	

Strutture UP-grade, T-flex e Team Tables - metallo | UP-grade, T-flex e Team Tables - Metal structures | Structures UP-grade, T-flex e Team Tables - mélamine

M2BD Bianco Dance White Dance Blanc Dance	M2AG Alluminio Goffrato Embossed Metal Alu Aluminium Gauffré	M3CF Cromo Funky Chrome Funky Chrome Funky
--	---	---

Solo per TEAM TABLES
Only for TEAM TABLES
Uniquement pour TEAM TABLES

Paretine divisorie - melaminico | Partition screens - MFC | Cloisons - mélamine

N3BD Bianco Dance White Dance Blanc Dance	N2GN Grigio Nuvola Cloud Grey Nuage Gris	N2AN Acero Nordic Nordic Maple Érable Nordic	N3RT Rovere Twist Durmast Twist Chêne Twist	N2NO Noce Walnut Noyer
N3RV Rovere Oak Chêne	N3NA Noce Napoli Walnut Napoli Noyer Napoli	N2GF Grigio Fango Mud Grey Gris Boue	N3NJ Nero Jazz Black Jazz Noir Jazz	

Struttura | Structure | Structure

M2AG Alluminio Goffrato Embossed Metal Alu Aluminium Gauffré

Piani Call Center - melaminico | Call Center - MFC worktops | Plateaux Call Center - mélamine

N3BD Bianco Dance White Dance Blanc Dance	N2GN Grigio Nuvola Cloud Grey Nuage Gris	N2AN Acero Nordic Nordic Maple Érable Nordic	N3RT Rovere Twist Durmast Twist Chêne Twist	N2NO Noce Walnut Noyer	N2GN Grigio Nuvola Cloud Grey Nuage Gris
N3RV Rovere Oak Chêne	N3NA Noce Napoli Walnut Napoli Noyer Napoli	N2GF Grigio Fango Mud Grey Gris Boue	N3NJ Nero Jazz Black Jazz Noir Jazz		

Struttura | Structure | Structure

Struttura Lockers - melaminico | Lockers - MFC structures | Structures Lockers - mélamine

N3BD Bianco Dance White Dance Blanc Dance	N2GN Grigio Nuvola Cloud Grey Nuage Gris	N3NJ Nero Jazz Black Jazz Noir Jazz
--	---	--

Ante, top e fianchi Lockers - melaminico | Lockers doors, finishing tops and side panels - MFC | Portes, tops et côtes de finition Lockers - mélamine

N3BD Bianco Dance White Dance Blanc Dance	N2GN Grigio Nuvola Cloud Grey Nuage Gris	N2AN Acero Nordic Nordic Maple Érable Nordic	N3RT Rovere Twist Durmast Twist Chêne Twist	N2NO Noce Walnut Noyer	N3RV Rovere Oak Chêne
N3NA Noce Napoli Walnut Napoli Noyer Napoli	N2GF Grigio Fango Mud Grey Gris Boue	N3NJ Nero Jazz Black Jazz Noir Jazz	N2VP Verde Pistacchio Pistachio Green Vert Pistache	N2AA Azzurro Artico Arctic Blue Arctic Blue	

UP-grade | UP-grade | UP-grade

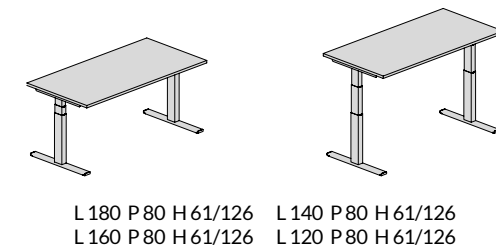

T-flex | T-flex | T-flex

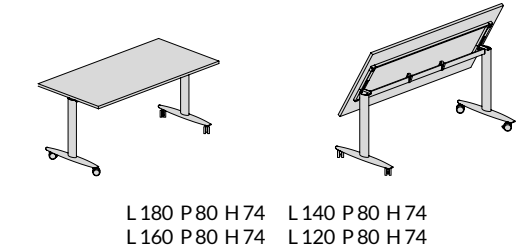

Team Tables | Team Tables | Team Tables

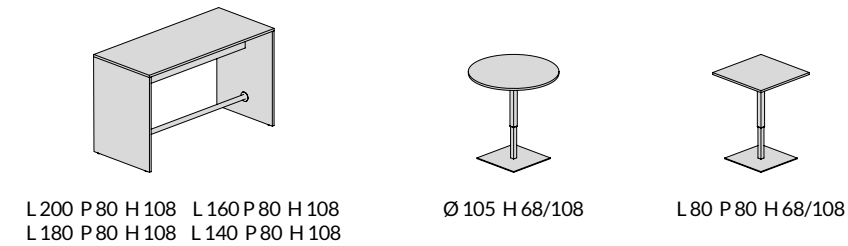

Paretine divisorie | Partition screens | Cloisons

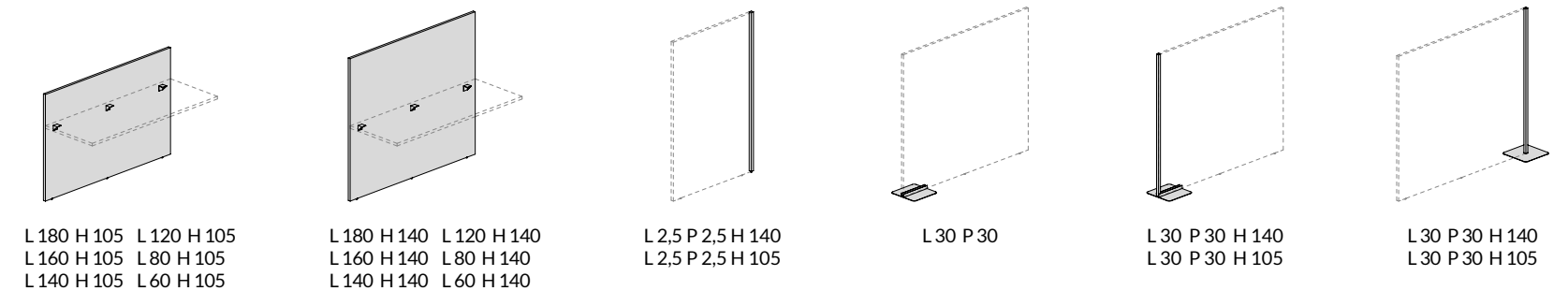

Call Center | Call Center | Call Center

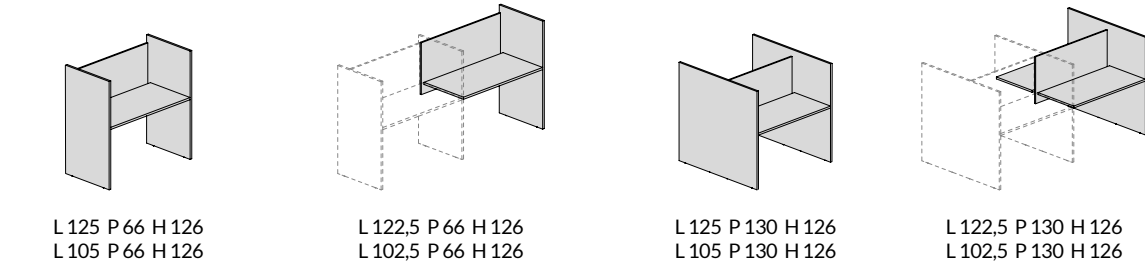

Lockers | Lockers | Lockers

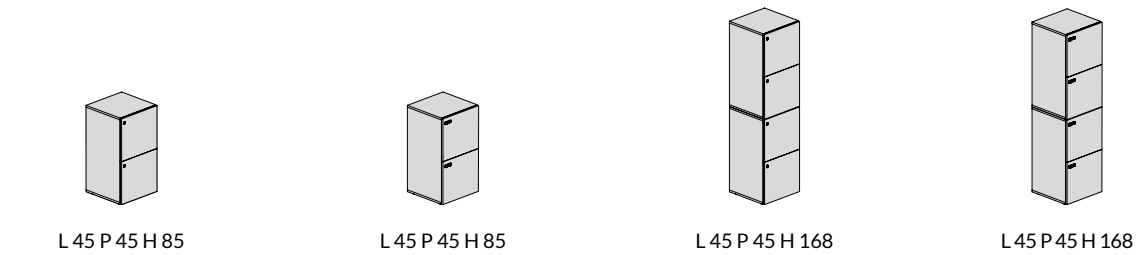

Reception

Reception

Réception

La reception è il luogo che rivela il carattere e l'immagine di un'azienda. Le linee pulite, le ampie superfici, i volumi, accolgono e soddisfano le necessità operative di chi lavora.

The reception environment sets the tone and reflects the image of a company. The clean lines, broad surfaces and shapes are welcoming and meet the functional needs of the people who work there.

La réception révèle le caractère et l'image d'une entreprise. Les lignes sobres, les volumes et les vastes surfaces accueillent et répondent aux besoins des réceptionnistes.





I diversi componenti e la varietà di finiture permettono di realizzare soluzioni compositive che danno risposte immediate alle priorità funzionali.

The different components and variety of finishes allow the creation of compositions that give immediate answers to functional priorities.

Les différents composants et la variété de finitions permettent de réaliser compositions qui donnent réponses immédiates aux priorités fonctionnelles.





La semplicità compositiva del bancone e la mensola ad altezza totale rappresentano il perfetto biglietto da visita per una reception flessibile ed elegante.

Neatness modularity of the counter and full height shelf perform as the perfect business card for a flexible and elegant reception.

La composition simple du comptoir et l'étagère à hauteur totale représentent la carte de visite parfaite d'une réception flexible et élégante.







Il piano di lavoro può essere attrezzato con funzionali box multiuso, da posizionare a piacere sotto la mensola top.

The work surface can be equipped with multipurpose functional boxes, arranged as desired below the top shelf.

Le plan de travail peut être équipé de caissons multifonctionnels, à positionner sous l'étagère supérieur.



La luce led funge da cornice per i mobili e le pareti creando effetti scenografici d'impatto. L'arredo risulta valorizzato e intrigante.

The LED light acts as a frame for the furniture units and walls creating impressive light sceneries. The decor is enriched and fascinating.

L'éclairage LED sert de décor aux meubles et murs, créant des effets scénographiques d'impact. Le mobilier est intrigant et mis en valeur.





Colori audaci, contrasto tra la finitura matt del melaminico e la riflessione del vetro creano ambienti attuali e dal carattere eccentrico.

Bold colours, contrast between the melamine matt finish and the reflection of the glass create contemporary settings with an eccentric character.

Les couleurs audacieuses, un contraste entre la finition mate du mélaminé et la réflexion du verre créent des environnements contemporains au caractère excentrique.





Mensole - melaminico sp. 18 | Shelves - MFC th.18 | Etagères - mélamine ép.18

N3BD	Bianco Dance White Dance Blanc Dance	N2GN	Grigio Nuvola Cloud Grey Nuage Gris	N2AN	Acero Nordic Nordic Maple Érable Nordic	N3RT	Rovere Twist Durmast Twist Chêne Twist
N2NO	Noce Walnut Noyer	N3RV	Rovere Oak Chêne	N3NA	Noce Napoli Walnut Napoli Noyer Napoli	N2GF	Grigio Fango Mud Grey Gris Boue
N3NJ	Nero Jazz Black Jazz Noir Jazz	N2VP	Verde Pistacchio Pistachio Green Vert Pistache	N2AA	Azzurro Artico Arctic Blue Arctic Blue		

Mensole - vetro sp.10 | Shelves - glass th.10 | Etagères - verre ép.10

E1BD	Bianco Dance White Dance Blanc Dance	E1GY	Grigio Yoga Yoga Grey Gris Yoga	V1NE	Nero Elegante Smart Black Noir Éléгант	E1TT	Titanio Titanium Titane
E1GF	Grigio Fango Mud Grey Gris Boue	V1BV	Blu Vivo Sparkling Blue Blue Brillant	E1MS	Marsala Marsala Marsala	V1MK	Moka Moka Moka
E1DE	Denim Denim Denim	E1VF	Verde Foresta Forest Green Forêt Verte				

Frontali - melaminico sp. 25 | Fronts - MFC | Façades - mélamine

N3BD	Bianco Dance White Dance Blanc Dance	N2GN	Grigio Nuvola Cloud Grey Nuage Gris	N2AN	Acero Nordic Nordic Maple Érable Nordic	N3RT	Rovere Twist Durmast Twist Chêne Twist
N2NO	Noce Walnut Noyer	N3RV	Rovere Oak Chêne	N3NA	Noce Napoli Walnut Napoli Noyer Napoli	N2GF	Grigio Fango Mud Grey Gris Boue
N3NJ	Nero Jazz Black Jazz Noir Jazz						

Frontali - laccato sp.25 | Fronts - lacquered th.25 | Façades - laqué ép.25

L2BD	Bianco Dance White Dance Blanc Dance	L2GY	Grigio Yoga Yoga Grey Gris Yoga	L2GF	Grigio Fango Mud Grey Gris Boue	L2GL	Glicine Wisteria Glycine
L2MS	Marsala Marsala Marsala	L2RM	Rosso Maranello Maranello Red Rouge Maranello	L2GZ	Giallo Zafferano Saffron Yellow Jaune Safran	L2TF	Tiffany Tiffany Tiffany
L2VM	Verde Muschio Moss Green Vert Mousse	L2VF	Verde Foresta Forest Green Forêt Verte	L2DE	Denim Denim Denim	L2BV	Blu Vivo Sparkling Blue Blue Brillant
L2TT	Titanio Titanium Titane	L2MK	Moka Moka Moka	L2NE	Nero Elegante Smart Black Noir Éléгант		

Piani - melaminico sp.25 | Desktops - MFC th.25 | Plateaux - mélamine ép.25

N3BD	Bianco Dance White Dance Blanc Dance	N2GN	Grigio Nuvola Cloud Grey Nuage Gris	N2AN	Acero Nordic Nordic Maple Érable Nordic	N3RT	Rovere Twist Durmast Twist Chêne Twist
N2NO	Noce Walnut Noyer	N3RV	Rovere Oak Chêne	N3NA	Noce Napoli Walnut Napoli Noyer Napoli	N2GF	Grigio Fango Mud Grey Gris Boue
N3NJ	Nero Jazz Black Jazz Noir Jazz						

Massima libertà di configurazione compositiva, materica e cromatica. I numerosi laccati si fondono ai melaminici e ai vetri offrendo molteplici abbinamenti.

Maximum freedom with combinations of compositions, materials and colours. The numerous lacquered finishes blend with the melamine and glass surfaces offering a myriad of combinations.

Une liberté maximale dans la configuration de la composition matérielle et chromatique. Les nombreux laqués se mélangent aux mélaminés et aux verres, offrant d'innombrables associations.

Archiviazione

Storages

Rangement

Progettare un ambiente idoneo alle esigenze lavorative è possibile con gli elementi contenitore, disponibili in varie dimensioni e funzioni. Grazie all'ampia scelta di finiture in melaminico, vetro e metallo si ottengono sistemi d'arredo unici, con strutture modulari e flessibili.

Designing an environment suitable for work requirements made possible with storage elements, available in various sizes and functions. Thanks to the wide choice of melamine, glass and metal finishes, unique furnishing systems are created, with modular and flexible structures.

La conception d'un environnement adapté aux besoins du travail est possible avec les éléments armoires, disponibles en différentes dimensions et fonctions. Grâce au large choix de finitions en mélaminé, verre et métal, on obtient des systèmes d'ameublement uniques, avec des structures modulaires et flexibles.

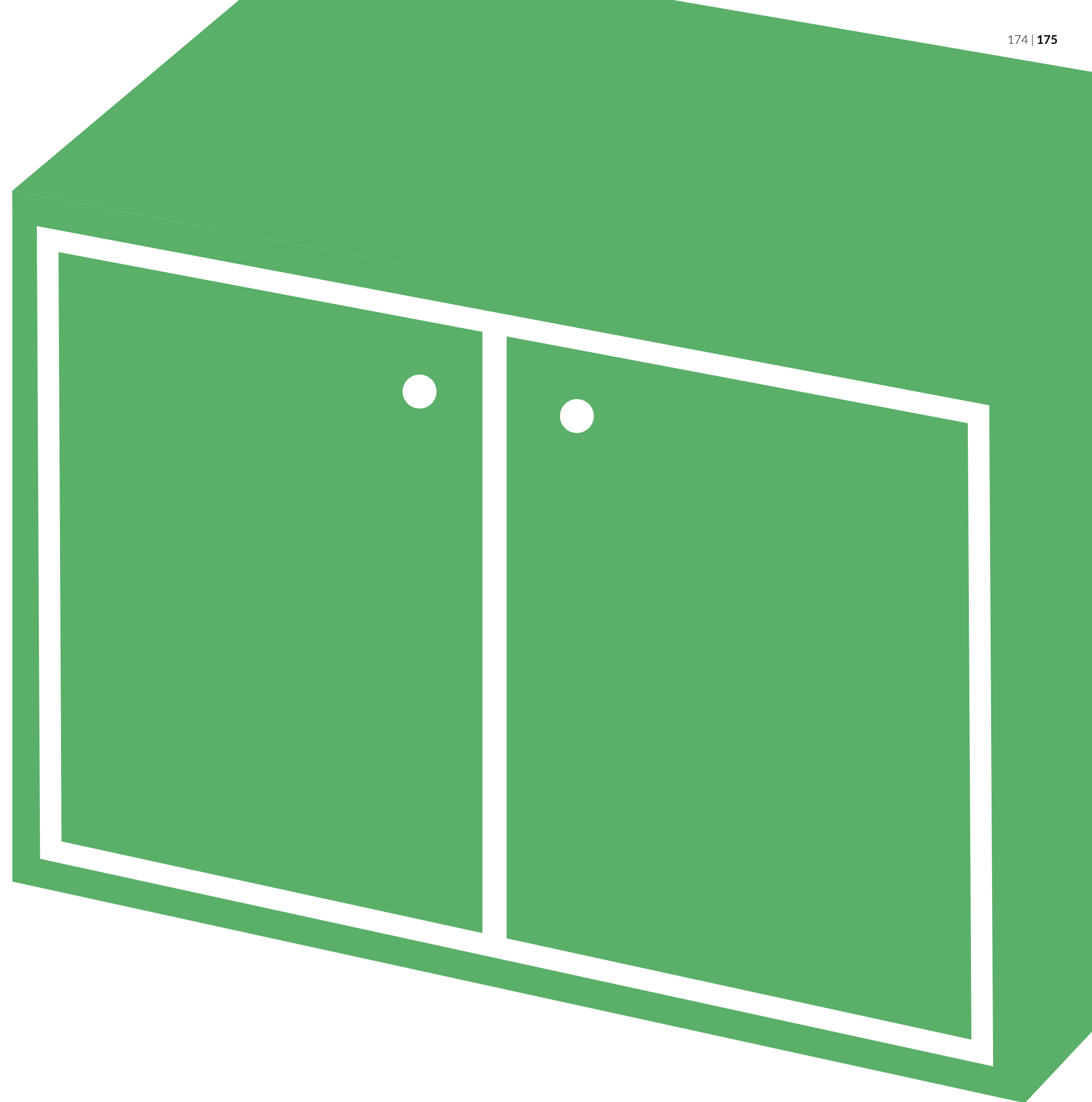

La configurazione dell'ufficio si compone di cassettiere, mobili di servizio e mobili filo-piano, sia in modalità freestanding, che di supporto alle singole postazioni.

The office configuration with combination of drawer units, service cabinets and desk height containers, both in freestanding mode as well as support units of individual workstations.

La configuration du bureau se compose de tiroirs, de meubles de service et de meubles hauteur bureau, soit en mode indépendant que de support à chaque poste.





Una concezione innovativa fatta di contenitori a giorno, con ante battenti o scorrevoli, per un'archiviazione professionale e un'organizzazione ottimale.



An innovative concept made of open containers, with hinged or sliding doors, for professional filing and optimal organization.

Une conception innovante faite d'armoires à jour, avec portes battantes ou coulissantes, pour un stockage professionnel et une organisation optimale.

Mobili di servizio e Cassettiere - melaminico | Service units and Pedestals - MFC | Meubles de service et Caissons - mélamine

 Bianco Dance White Dance Blanc Dance	 Grigio Nuvola Cloud Grey Nuage Gris	 Acero Nordic Nordic Maple Érable Nordic	 Rovere Twist Durmast Twist Chêne Twist	 Noce Walnut Noyer
 Rovere Oak Chêne	 Noce Napoli Walnut Napoli Noyer Napoli	 Grigio Fango Mud Grey Gris Boue	 Nero Jazz Black Jazz Noir Jazz	









Cassettiere - metallo | Pedestals - metal | Caissons - métal

 Bianco Dance White Dance Blanc Dance	 Nero Elegante Smart Black Noir Éléгант	 Alluminio Goffrato Embossed Metal Alu Aluminium Gaufré
--	---	---

Struttura Contenitori filo-piano - melaminico | Desk height containers structure - MFC | Structure armoires hauteur bureau - mélamine

 Bianco Dance White Dance Blanc Dance	 Nero Jazz Black Jazz Noir Jazz
--	---

Ante e top Contenitori filo-piano - melaminico | Desk height containers doors and top - MFC | Portes et tops armoires hauteur bureau - mélamine

 Bianco Dance White Dance Blanc Dance	 Grigio Nuvola Cloud Grey Nuage Gris	 Acero Nordic Nordic Maple Érable Nordic	 Rovere Twist Durmast Twist Chêne Twist	 Noce Walnut Noyer	 Rovere Oak Chêne
 Noce Napoli Walnut Napoli Noyer Napoli	 Grigio Fango Mud Grey Gris Boue	 Nero Jazz Black Jazz Noir Jazz			



Sopralzo e schienale - melaminico | Open shelf units and rear panels - MFC | Unité du haut et dos rehausse - mélamine

 Bianco Dance White Dance Blanc Dance	 Grigio Nuvola Cloud Grey Nuage Gris	 Acero Nordic Nordic Maple Érable Nordic	 Rovere Twist Durmast Twist Chêne Twist	 Noce Walnut Noyer	 Rovere Oak Chêne
 Noce Napoli Walnut Napoli Noyer Napoli	 Grigio Fango Mud Grey Gris Boue	 Nero Jazz Black Jazz Noir Jazz	 Verde Pistacchio Pistachio Green Vert Pistache	 Azzurro Artico Artic Blue Arctic Blue	

Sopralzo e schienale - laccato | Open shelf units and rear panels - lacquered | Unité du haut et dos rehausse - laqué

 Bianco Dance White Dance Blanc Dance	 Grigio Yoga Yoga Grey Gris Yoga	 Grigio Fango Mud Grey Gris Boue	 Glicine Wisteria Glycine	 Marsala Marsala Marsala	 Rosso Maranello Maranello Red Rouge Maranello
 Giallo Zafferano Saffron Yellow Jaune Safran	 Tiffany Tiffany Tiffany	 Verde Muschio Moss Green Vert Mousse	 Verde Foresta Forest Green Forêt Verte	 Denim Denim Denim	 Blu Vivo Sparkling Blue Blue Brillant
 Titanio Titanium Titane	 Moka Moka Moka	 Nero Elegante Smart Black Noir Éléгант			

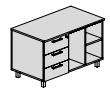
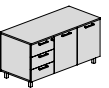
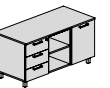
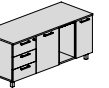
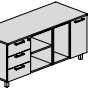

Mobili di servizio e Cassettiere - melaminico | Service units and Pedestals - MFC | Meubles de service et Caissons - mélamine

						
L 102 P 57 H 62	L 125 P 57 H 62	L 125 P 57 H 62	L 143 P 57 H 62	L143 P 57 H 62	L 41,5 P 55 H 60	L 41,5 P 55 H 60

Cassettiere - metallo | Pedestals - metal | Caissons - métal

		
L 42,5 P 53 H 58	L 42,5 P 53 H 58	L 42,5 P 53 H 58

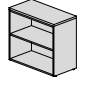
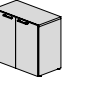
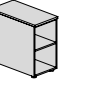
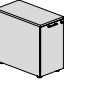
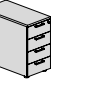
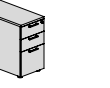
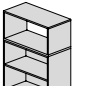
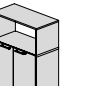
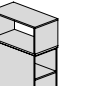
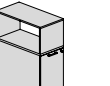
Contenitori filo-piano | Desk height containers | Armoires hauteur bureau

					
L 80 P 41,5 H 75	L 80 P 41,5 H 75	L 80 P 41,5 H 75 L 60 P 41,5 H 75	L 80 P 41,5 H 75 L 60 P 41,5 H 75	L 80 P 41,5 H 75 L 60 P 41,5 H 75	L 80 P 41,5 H 75 L 60 P 41,5 H 75
					
L 80 P 41,5 H 113	L 80 P 41,5 H 113	L 80 P 41,5 H 113 L 60 P 41,5 H 113	L 80 P 41,5 H 113 L 60 P 41,5 H 113	L 80 P 41,5 H 113 L 60 P 41,5 H 113	L 80 P 41,5 H 113 L 60 P 41,5 H 113

Strutture contenitori - melaminico sp.18 | Storage unit structures - MFC th. 18 | Structures armoires - mélamine ép.18

M2BD	Bianco Dance White Dance Blanc Dance	N2GN	Grigio Nuvola Cloud Grey Nuage Gris	N3NJ	Nero Jazz Black Jazz Noir Jazz
-------------	---	-------------	--	-------------	---

Ante, top e fianchi di finitura - melaminico sp.18 | Doors, finishing top and side panels - MFC th. 18 | Portes, tops et côtés de finition - mélamine ép.18

N3BD	Bianco Dance White Dance Blanc Dance	N2GN	Grigio Nuvola Cloud Grey Nuage Gris	N2AN	Acero Nordic Nordic Maple Érable Nordic	N3RT	Rovere Twist Durmast Twist Chêne Twist
N2NO	Noce Walnut Noyer	N3RV	Rovere Oak Chêne	N3NA	Noce Napoli Walnut Napoli Noyer Napoli	N2GF	Grigio Fango Mud Grey Gris Boue
N3NJ	Nero Jazz Black Jazz Noir Jazz						







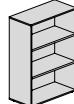
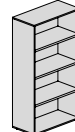
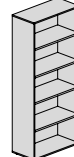
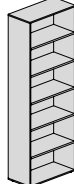

Ante contenitori - vetro sp.4 | Storage unit doors - glass th. 4 | Portes armoires - verre ép.4

V2VS	Vetro Satinato Satinated Glass Verre Satiné	V1GE	Grigio Europeo European Grey Gris Européen
-------------	--	-------------	---

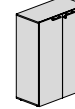
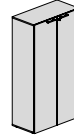
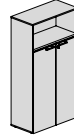
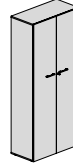

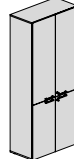
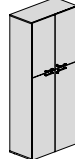

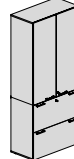
Contenitori a giorno | Open storage units | Armoires à jour

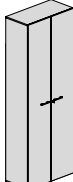
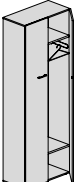
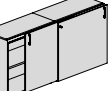
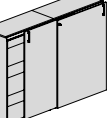
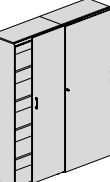
				
L 90 P 43 H 85 L 90 P 33 H 85 L 45 P 43 H 85 L 45 P 33 H 85	L 90 P 43 H 127 L 90 P 33 H 127 L 45 P 43 H 127 L 45 P 33 H 127	L 90 P 43 H 168 L 45 P 43 H 168	L 90 P 43 H 210 L 90 P 33 H 210 L 45 P 43 H 210 L 45 P 33 H 210	L 90 P 43 H 251 L 45 P 43 H 251

Contenitori con ante in melaminico | Storage units with MFC doors | Armoires avec portes en mélamine

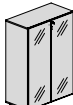
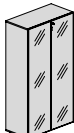
					
L 90 P 45 H 85 L 90 P 35 H 85 L 45 P 45 H 85 L 45 P 35 H 85	L 90 P 45 H 85 L 45 P 45 H 85	L 90 P 45 H 127 L 90 P 35 H 127 L 45 P 45 H 127 L 45 P 35 H 127	L 90 P 45 H 168 L 45 P 45 H 168	L 90 P 45 H 168 L 45 P 45 H 168	L 90 P 45 H 210 L 90 P 35 H 210 L 45 P 45 H 210 L 45 P 35 H 210
					
L 90 P 45 H 210 L 45 P 45 H 210	L 90 P 43 H 210 L 90 P 33 H 210 L 45 P 43 H 210 L 45 P 33 H 210	L 90 P 43 H 210 L 90 P 33 H 210 L 45 P 43 H 210 L 45 P 33 H 210	L 90 P 45 H 210 L 90 P 35 H 210 L 45 P 45 H 210 L 45 P 35 H 210	L 90 P 45 H 210	L 90 P 45 H 210
					
L 90 P 45 H 251 L 45 P 45 H 251	L 90 P 45 H 251 L 45 P 45 H 251		L 180 P 50,5 H 88	L 180 P 50,5 H 130	L 180 P 50,5 H 213

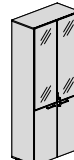
Contenitori con ante in vetro e telaio alluminio | Storage units with aluminium framed glass doors | Armoires avec portes en verre et cadre en aluminium

				
L 90 P 45 H 127 L 90 P 35 H 127 L 45 P 45 H 127 L 45 P 35 H 127	L 90 P 45 H 168 L 45 P 45 H 168	L 90 P 45 H 210 L 90 P 35 H 210 L 45 P 45 H 210 L 45 P 35 H 210	L 90 P 45 H 210 L 90 P 35 H 210 L 45 P 45 H 210 L 45 P 35 H 210	L 90 P 45 H 210

Contenitori con ante in vetro senza telaio | Storage units without framed glass doors | Armoires avec portes en verre sans cadre

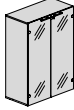
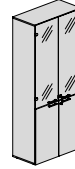
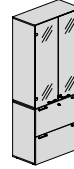
			
L 90 P 45 H 127 L 90 P 35 H 127 L 45 P 45 H 127 L 45 P 35 H 127	L 90 P 45 H 168 L 45 P 45 H 168	L 90 P 45 H 210 L 90 P 35 H 210 L 45 P 45 H 210 L 45 P 35 H 210	L 90 P 45 H 210 L 90 P 35 H 210 L 45 P 45 H 210 L 45 P 35 H 210



Top Acces



Pamar



Versaflap



Carrè Ø 80



Exit



Versacharge - Versapick



Mobilpref S.p.A. si riserva il diritto di apportare ai propri prodotti le modifiche ritenute utili o necessarie, senza pregiudicare le caratteristiche essenziali dei prodotti stessi. Foto e testi copyright Mobilpref S.p.A. Riproduzione senza autorizzazione non permessa.

Mobilpref S.p.A. reserves the right to apply changes to products deemed useful or necessary without compromising the essential product features. Photos and texts copyright Mobilpref S.p.A. Reproduction without authorization not allowed.

Mobilpref S.p.A. se réserve le droit d'apporter les modifications jugées utiles ou nécessaires à ses propres produits, sans compromettre les caractéristiques essentielles des produits eux-mêmes. Photos et textes Copyright Mobilpref S.p.A. La reproduction sans autorisation est interdite.





Mobilpref S.p.A.
Via Carlo Maccari, 10
Zona Industriale Baraccola Sud
60131 Ancona (AN) Italy
t. +39 071 290 6920 / f. +39 071 286 6429
info@about-office.it / www.about-office.it